

For fifty years LAND have supplied temperature measuring systems and instruments to many different industries all over the world. Now the world leader in non contact thermometry, our expert advice and support is never far away.



APPLICATIONS

LAND have solved many different temperature measurement problems in a wide variety of industries from food to atomic energy, some of which are listed below:

- Iron & Steel
- Heat Treatment
- Non-ferrous Metals
- Minerals
- Glass
- Petrochemical
- Power & Utilities
- Aerospace
- Electronics
- Pharmaceuticals
- Plastics
- Paper
- Rubber
- Textiles
- Maintenance

For further information or free advice on specific temperature measurement problems within these or any other industry, contact your nearest Land office.

PRODUCT ASSURANCE

When you specify LAND products you are assured of receiving a completely pretested, calibrated working product. Each instrument is carefully checked to ensure complete compliance with specification and is fully guaranteed. LAND was the first manufacturer of infrared instruments to successfully obtain ISO 9001 Quality Management System Approval for both design and manufacture of non contact infrared temperature measuring equipment.

 These products with current European directives relating to electromagnetic compatibility and safety (EMC directive 89/336/EEC; Low voltage directive 73/23/EEC).

WORLDWIDE SUPPORT

In addition to the companies established in the U.S.A., Europe and Japan, LAND is represented by distributors in most of the major industrial countries throughout the world.

Our customers benefit, on a global basis, from practical and expert advice from fully trained technicians who are aware of specific requirements for their country and industry.

CALIBRATION

LAND operate an extensive calibration service. All calibrations made are traceable to National Standards. In the UK, LAND can issue a UKAS calibration certificate.

In the U.S.A. a traceable calibration certificate can be issued complying with the National Institute of Standards and Technology (NIST).

LAND also supply a full range of temperature reference sources which are used to verify or re-establish the accuracy of calibration in the field or in the laboratory.

A consultancy service is also available for those companies who wish to establish their own in-house calibration facility.

LAND



SYSTEM 4

PROCESSORS AND
SYSTEM OVERVIEW

LAND

Non-Contact Temperature
Measurement Solutions

Land Instruments International Ltd • Dronfield S18 1DJ • England
Email: land.infrared@ametek.co.uk • www.landinst.com • Tel: +44 (0) 1246 417691 • Fax: +44 (0) 1246 410585

AMETEK Land, Inc. • 150 Freeport Rd • Pittsburgh, PA 15238 • U.S.A.
Email: irsales@ametek.com • www.ametek-land.com • Tel: +1 (412) 826 4444 • Fax: +1 (412) 826 4460

For a full list of international offices, please visit our website.



An AMETEK Company

Applies in the UK

Applies in the USA

An AMETEK Company

SYSTEM 4

LAND

For over 50 years, Land have been the world leaders in delivering solutions to temperature measurement problems.

SYSTEM 4 gives you a choice of products which covers all applications, environments and budgets, ensuring premium performance at competitive prices. Compatibility and interchangeability of each product ensures maximum flexibility, both at time of purchase and subsequently for easy maintenance.

Non contact temperature measuring systems are designed for continuous quality and process monitoring and control in a wide range of industries. They can be used in a variety of applications such as metal production, processing, foundry and forging, glass, electronics, mineral processing and petrochemical where accurate measurement of temperature is vital.

No other method of temperature measurement offers the benefits of non contact infrared radiation thermometry.

- Infrared radiation thermometer systems measure continuously the temperature of hot, moving or normally inaccessible materials accurately and safely at a distance.
- Sensing heads do not require contact with the target object, and therefore cannot interfere with, damage or contaminate the product they are measuring.
- Thermometers do not remove heat or disturb the process being monitored and offer the only solution when the product is small, fragile or in a vacuum or controlled atmosphere.

SYSTEM 4 gives you a wide choice of compatible items to ensure the system you buy is optimized to meet the needs of your application, budget and environment.

LANDMARK® processors are designed to produce the process control variables you need from ANY of the **SYSTEM 4** sensors. With this total compatibility, you are free to choose a processor to give the features and performance you need and select the sensor type best suited to the application. All **SYSTEM 4** processors and sensors are calibrated individually to guarantee interchangeability and hence easy maintenance for many years.

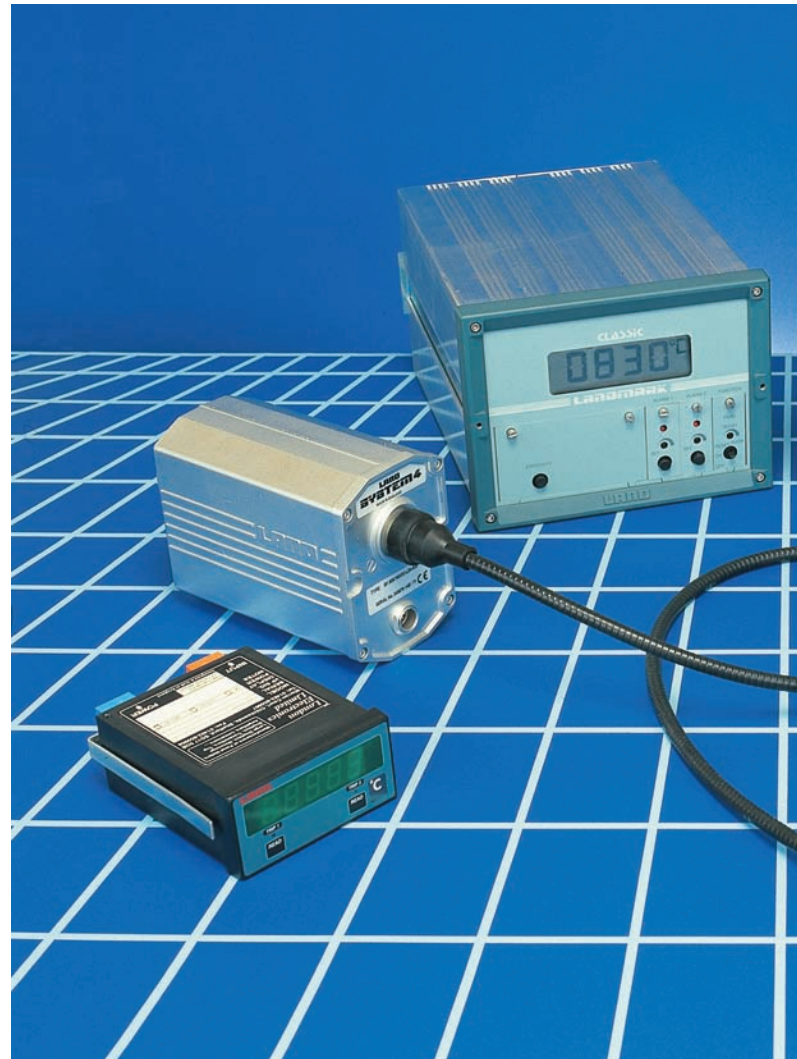

SYSTEM 4 offers an extensive, and expanding, range of Standard and Fibroptic thermometers, designed to cover all industrial non contact temperature measurement applications.



THERMOMETER MOUNTINGS AND ACCESSORIES

Both the Standard bodied and Fibroptic range of mounting accessories are subdivided into three groups which cover all environmental conditions i.e. **INDUSTRIAL**, **NON-HOSTILE** and **LABORATORY**.

INDUSTRIAL

Where severe or extreme environmental conditions prevail.

NON-HOSTILE

Where the environmental conditions which apply to the measurement application are less severe.

LABORATORY

No adverse environmental conditions prevail, a requirement for thermometer mounting only.

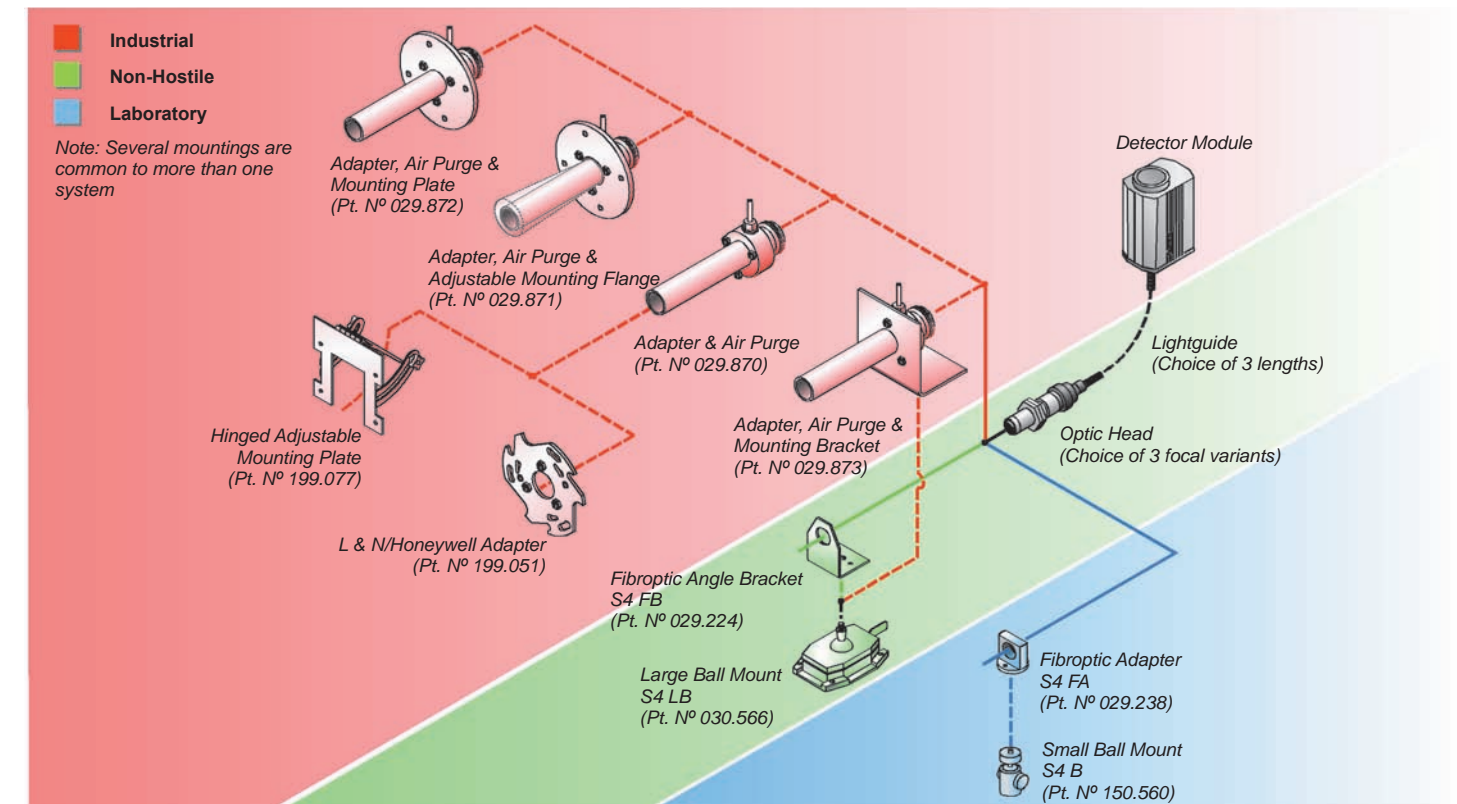
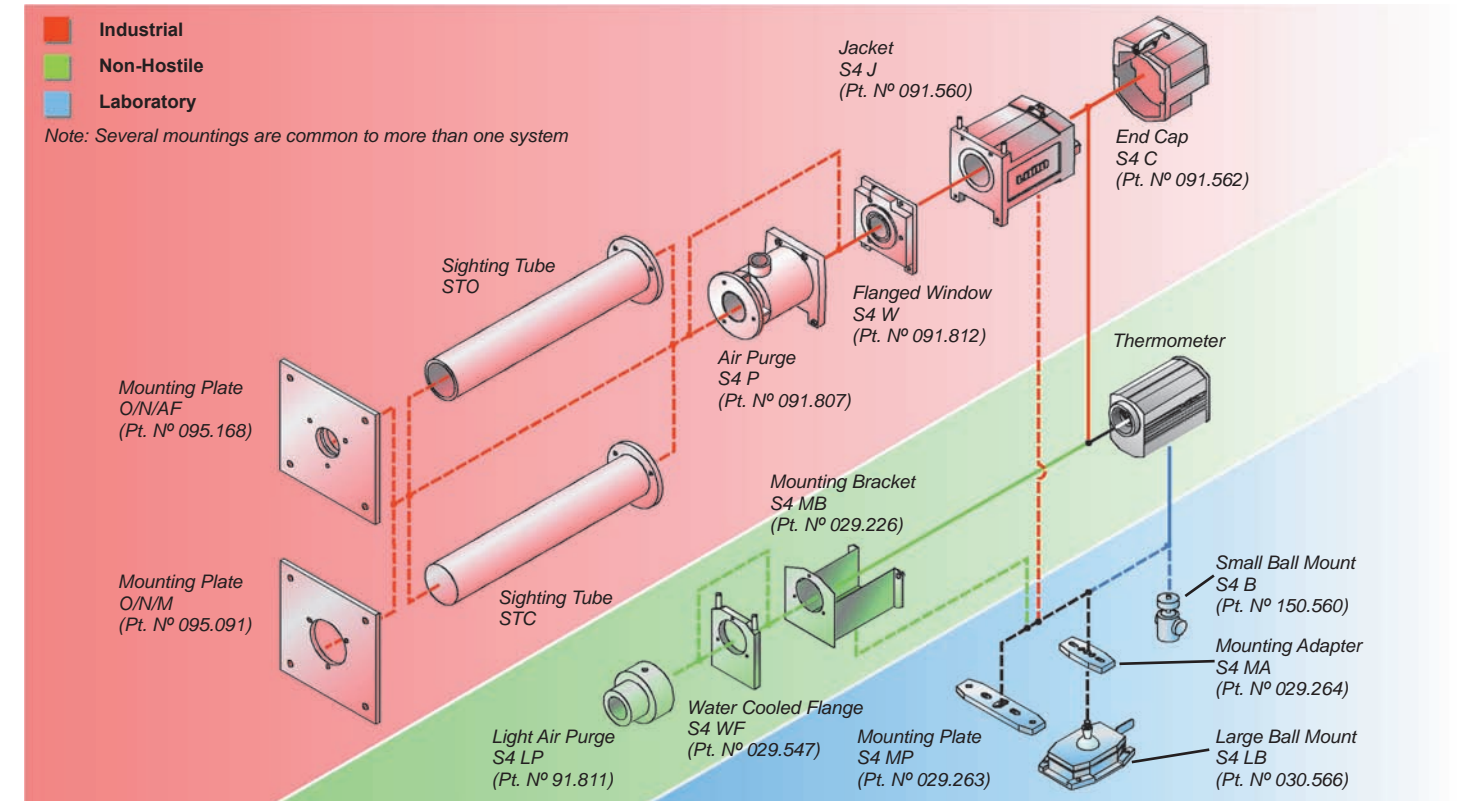

THERMOMETER MOUNTINGS AND ACCESSORIES

To enable you to measure temperature accurately in even the most severe operating conditions, a complete range of thermometer protection and mounting accessories is available.

Full mechanical and thermal protection for the thermometer and electrical connections is ensured, giving uninterrupted service with minimal maintenance in almost any environment.

JACKET

The corrosion resistant thermometer jacket provides air or water cooling where excessive heat may exist.

The jacket allows quick, no-tools thermometer installation and removal and ensures reproducible alignment.

END CAP

The end cap provides protection for the rear of the thermometer. The ingenious design, featuring a pre-wired thermometer connector and a terminal strip inside the end cap simplifies customer connections on-site.



THERMOMETER CONNECTOR

The thermometer connector is normally supplied pre-wired and terminated in the end cap. A connector pre-wired to 4m of cable must be ordered if the user does not require an end cap for the application.

AIR PURGE

Extensive research has resulted in a highly efficient air purge which keeps condensation, dirt and other deposits off the thermometer lens. The air purge also helps to disperse fumes and smoke from the thermometer sight path.

The purge accepts a range of air entry adapters and fittings, and has the added bonus of being suitable for use with both fan or compressed air supplies.

The front flange of the purge also mounts directly onto the Land System 3 range of mounting plates and sighting tubes.

SIGHTING TUBES

A range of Silicon Carbide, Sillimanite and Stainless Steel sighting tubes are available in various lengths up to 1200mm for use in temperatures up to 1550°C.

Open ended sighting tubes (Type STO) are used to ensure a clear view of a solid target through flame, smoke, fumes and dust. Closed-end sighting tubes (Type STC) are used to measure the temperature of a fluid material.

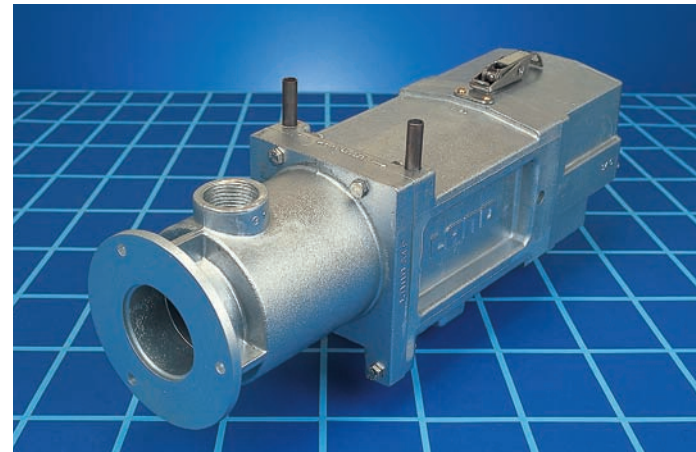

MOUNTING PLATES

Mounting plates enable the thermometer, together with a jacket, purge and sighting tube, to be securely mounted in a safe position to monitor the product or process.

O/N/M mounting plate is a simple, rugged mounting which can be used with all of the sighting tubes.

O/N/AF adjustable mounting plate is for use where accurate sighting is essential. The jacket/ purge fastens to an adjustable circular plate. The O/N/AF mounting is used with the FS6 and FS36 sighting tubes.



FIBROPTIC MOUNTINGS AND ACCESSORIES

QUICK-RELEASE AND AIR PURGE ASSEMBLY

The quick release and air purge/sighting tube assembly attaches to the optic head of the fibroptic thermometer to keep the lens clean.

The assembly can be used with a range of mounting accessories.

MOUNTING PLATE ASSEMBLY

A simple, robust 127mm diameter mounting plate and quick release/air purge assembly permits a range of mounting options.



ANGLE MOUNTING BRACKET ASSEMBLY

A simple mounting bracket serves as an inexpensive mounting for the thermometer optic head. The bracket is designed for bolting to almost any mounting surface.

ADJUSTABLE MOUNTING FLANGE ASSEMBLY

The adjustable mounting flange and quick release/air purge assembly provides accurate alignment of the optic head.

ADJUSTABLE MOUNTING PLATE

An adjustable mounting flange allows alignment of the optic head at any angle up to 45°.



PROCESSORS

The heart of any temperature measurement system is the signal processor. A LANDMARK® signal processor puts the controls of your system where you need them - panel mounted or DIN rail mounted, the choice is yours. **SYSTEM 4** uses high speed inputs, real time signal processing and flexible outputs to convert the output of each sensor into real process variables.

LANDMARK® GRAPHIC is the state-of-the-art, panel mounted signal processor, designed to control and process data from *any* **SYSTEM 4** Thermometer. The Multi-channel processor accepts, processes and displays inputs from *any combination* of up to four separate thermometers simultaneously - it is *not* multiplexed. Multiple outputs are provided which can be integrated directly into any process monitoring, recording or control system.

LANDMARK® GRAPHIC processors offer a variety of features and advanced time functions which present temperature data in a choice of displays and outputs to suit the particular application.

LANDMARK® GRAPHIC processors are rugged, and extremely versatile, utilizing the latest technology available, giving you more choice and more precision in the measurement of temperature.

For applications which do not require this high level of processor power, a simple alternative is available - **LANDMARK® CLASSIC**.

LANDMARK® CLASSIC can be used with any **SYSTEM 4** Thermometer. It displays the measured temperature and optional plug-in cards give you a choice of either a peak picker or averager time function, plus up to two alarm modules.

LANDMARK® TECHNIC is a high precision, DIN-rail mounted intelligent digital processor. Its features include adjustable emissivity/non-greyness, peak picker, averager, track and hold, alarm and 4 to 20mA outputs, and RS232C serial communications for set up via a PC.

LANDMARK® BASIC is a simple DIN-rail mounted signal processing unit, providing simple signal conditioning with economy and versatility.

THERMOMETERS

Infrared radiation thermometers do not require contact with the target object, so they cannot interfere with, damage, or contaminate the product they are measuring. They do not remove heat or disturb the process being monitored and offer the only solution when the product is moving, small, fragile, or in a vacuum or controlled atmosphere.

SYSTEM 4 Thermometers all feature temperature spans and operating wavebands selected to ensure optimum accuracy of measurement for each application.

Any **SYSTEM 4** thermometer, selected from the extensive range available, can be used with *any* **SYSTEM 4 LANDMARK®** processor, allowing you to build a temperature measurement system designed specifically to your application requirements.

Standard thermometers feature precision through-the-lens focusable optics which guarantee exact viewing and accurate measurement of the smallest of target areas.

Single wavelength thermometers are intended for both general purpose use as well as solving problems in specific applications.

Fibroptic thermometers are used to measure the temperature of materials where the target is difficult to access, and where high temperature or high magnetic fields prevent the use of other types of sensor.

Ratio thermometers are used in difficult environments containing steam, smoke, or dust, or where the target is small or does not completely fill the field of view.

For more details, refer to the 'System 4 Standard and Fibroptic Thermometers' Brochure.

GRAPHIC SYSTEM 4

LANDMARK® GRAPHIC is the premier non contact temperature measurement system offering an extensive range of standard features and user benefits.

- Highest system accuracy
- High speed, high precision, real time signal processing
- Unique Multi-channel and Math Function options
- Modular, expandable system design
- Simple, user-friendly interface with large numeric and graphic displays
- Selectable time functions and alarm settings
- 0 to 20mA, 4 to 20mA and 1mV/° outputs to suit all industry control systems
- Optional Serial Communications

LANDMARK® GRAPHIC is a high precision, intelligent multiple microprocessor-based thermometer signal processor, designed to give the ultimate in process monitoring and control.

LANDMARK® GRAPHIC processors are multi-channel capable and can be configured to work with up to four different **SYSTEM 4** thermometers simultaneously.

A Math Function option is available which applies user-configured math functions to the temperature measurement signals from the thermometers in the system.

The processor supplies power to each thermometer and the control signals required for either emissivity or non-greyness compensation. A large LCD display shows temperature and parameter variables, and system outputs.

A complete range of thermometer signal conditioning functions is provided including: peak picker, averager, track and hold, and alarm outputs.

Typical Difference display

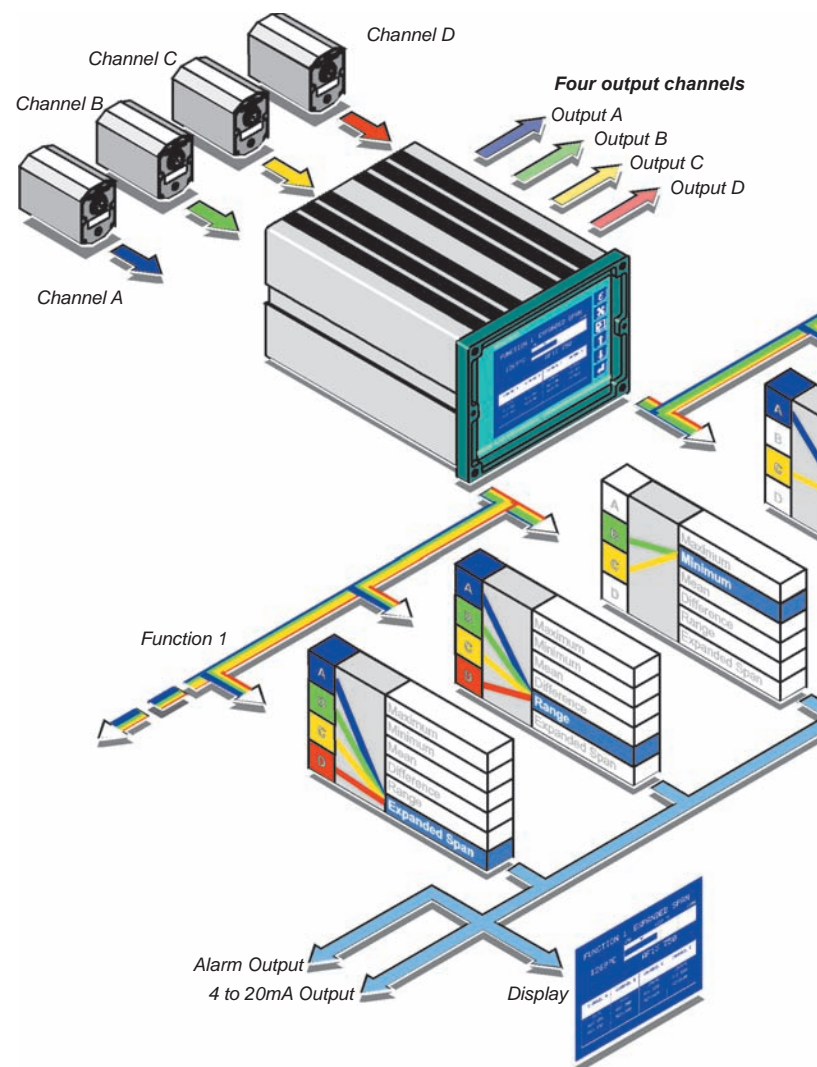
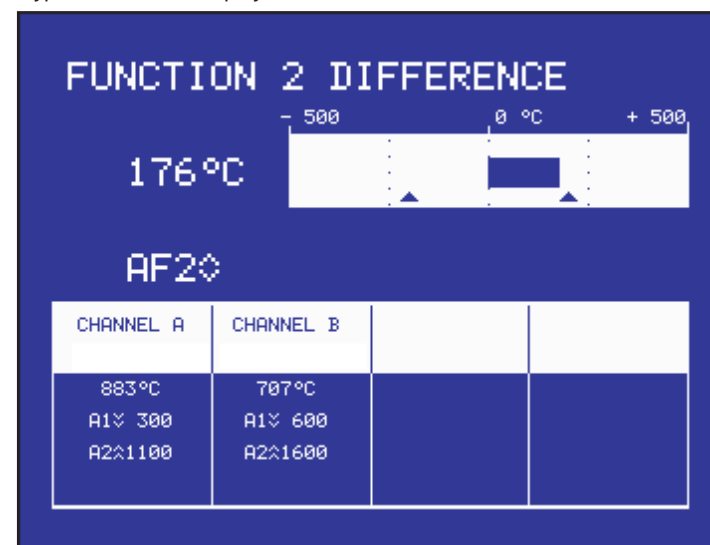

Landmark Graphic Processor fitted with Math function option

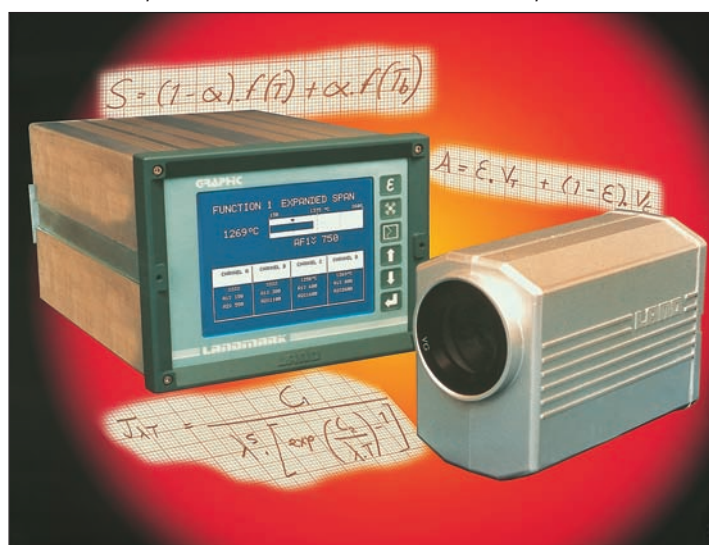

System 4 THERMOMETERS offer exceptional flexibility with a choice of single wavelength, ratio, fibroptic and fibroptic ratio models.

Thermometer type, temperature range, spectral response and optical characteristics are chosen to suit any application from 0 to 2600°C.

- Focusable optics - guaranteeing 98% of target energy within the lens graticule. Optics remain focusable during operation
- Additional close-up lenses for 'standard bodied' thermometers for targets as small as 0.45mm
- Flexible fibre optics light guide versions - with optional laser targeting system to define target size and position
- Traceable, individual calibration - giving flexible systems with unrestricted interchangeability
- Long term accurate, reliable and drift-free measurement
- Rugged design with a wide range of mounting accessories

STANDARD BODIED THERMOMETERS

Proven reliable electronics and a high quality optical system are housed in a rugged die-cast aluminium body with a robust electrical connector to provide reliable performance. All thermometers feature through-the-lens sighting. Adjustable focus with a circular graticule gives precise alignment on to the smallest of targets. Two optical variants are available: Standard and Short-focus.

System 4 Standard Bodied and Fibroptic Thermometers



M1 Thermometers

M1 thermometers are intended for general purpose use in high temperature applications from 450 to 2600°C. They utilize a silicon cell detector and operate at short wavelengths and have a fast response time of 5ms to 95%.

M2 Thermometers

M2 thermometers use the latest generation of germanium detectors and operate at a wavelength of 1.6µm. They extend the measurement range of short wavelength thermometers down to 300°C and have a fast response time of 5ms.

M4 Thermometers

M4 thermometers measure from 50 to 550°C and are used on low temperature, partially obscured, low or uncertain emissivity surfaces such as bright or unoxidized metals. They use lead sulphide detectors in a unique null balance mode to guarantee stability.

M5 Thermometers

The fast speed of response, coupled with small target size and accurate sighting facility make the M5 thermometers ideal for all flat glass, glass toughening and optical fibre preform applications. They measure from 400 to 2500°C.

M6 Thermometers

The unique M6 short wavelength thermometers measure from 0 to 700°C and are designed specifically for lower temperature applications such as metal processing, glass lehr, food, paper, rubber and textiles.

M7 Thermometers

M7 thermometers operate at a waveband selected especially for measurement on plastic films as thin as a few microns, such as Polyethylene and PVC, and measure from 25 to 375°C.

M8 Thermometers

M8 thermometers measure from 0 to 1000°C and are ideal for applications such as food, textiles, paper and plastics. They operate at a waveband which avoids the effects of atmospheric absorption.

R1 Ratio Thermometers

R1 Ratio Thermometers are intended for difficult, high temperature applications where the field of view is not fully filled or where the sight path is obscured. Their range is 600 to 2600°C and can accurately measure temperature of targets with up to 95% obscuration.

FIBROPTIC THERMOMETERS

Fibroptic models have a flexible fibre optics light guide which enables the detector and electronics enclosure to be located in a less hostile environment.

Fibroptic M1 Thermometers

Fibroptic M1 thermometers measure from 600 to 2600°C and combine the flexibility of fibre optics with short wavelength operation. They can be used in high temperature applications such as metals, glass, coke ovens and induction heating.

Fibroptic M2 Thermometers

Fibroptic M2 thermometers are designed for applications from 300 to 1100°C, such as glass mould temperatures where access to the target is restricted, or limited to a few milliseconds.

Fibroptic M3 Thermometers

The Fibroptic M3 thermometers is designed for low temperature applications, with low or uncertain emissivity, such as secondary metals, within the range 50 to 250°C.

Fibroptic R1 Ratio Thermometers

Fibroptic R1 ratio thermometers measure from 600 to 2600°C and provide accurate high temperature measurement of small intermittent targets, such as rod and wire, and tube welding. Other typical applications include kilns and vacuum furnaces.

SPECIFICATIONS

	Landmark Graphic	Landmark Classic	Landmark Technic	Landmark Basic					
Display	Cold cathode, backlit, 320 x 240 pixels	LCD	Optional LMi Indicator	Optional LMi Indicator					
Outputs	4 to 20mA, 0 to 20mA, 1mV/°	4 to 20mA over temperature range	0 to 20mA or 4 to 20mA	4 to 20mA over temperature range					
Output update	10ms	5ms to 98% (without time function module)	10ms	3ms to 98% (time functions at minimum)					
Emissivity	0.050 to 1.000 in 0.001 steps**	0.20 to 1.00	0.200 to 1.000 in 0.001 steps	0.20 to 1.00					
Non Greyness	0.800 to 1.250 in 0.001 steps	0.800 to 1.250	0.800 to 1.250 in 0.001 steps	0.800 to 1.250					
Peak Picker	Yes	Optional	Yes	Yes					
Averager	Yes	Optional	Yes	Yes					
Track and Hold	Yes	No	Yes	No					
Alarms	Yes	Optional	Yes	No					
Serial Comms.	Optional	No	Yes	No					
Power requirement	90 to 132V a.c. or 180 to 264V a.c. 48 to 63 Hz, 35VA (290VA max with 4 thermometers)	90 to 132V a.c. or 180 to 264V a.c. 48 to 63 Hz, 35VA	30V d.c. nominal	24 to 30V a.c. 50 to 60Hz or 30 to 45V d.c at 200mA					
Ambient operating temperature	5 to 50°C (specified) 5 to 60°C (max. operating)								
Sealing	To requirements of IP65/NEMA4 (with optional cover fitted)		IP40, IP20 to terminals						
Humidity	0 to 99% non condensing								
Vibration	1g any axis, 10 to 300Hz								
Weight	5.5kg approx.	4.3kg approx.	0.5kg approx	0.2kg approx.					
CE	EN 50-082-2 (immunity), EN 50-081-1 (emission), IEC 1010 (safety)								
System Accuracy	<i>Repeatability*</i>	<i>Accuracy*</i>	<i>Repeatability*</i>	<i>Accuracy*</i>	<i>Repeatability*</i>	<i>Accuracy*</i>	<i>Repeatability*</i>	<i>Accuracy*</i>	
Thermometers	M1 450/1000C	<1K	0.4%K	<1K	0.5%K	<1K	0.4%K	<1K	0.6%K
	M1 600/1600C	<1K	0.25%K	<1K	0.5%K	<1K	0.25%K	<1K	0.6%K
	M1 800/2600C	<2K	0.4%K	<2K	0.75%+1K	<2K	0.4%K	<2K	0.9%+1K
	M2 300/1100C	<1K	2K	<1K	0.25%+2K	<1K	2K	<1K	0.4%+2K
	M3 50/250C ⁽¹⁾	<1.5K	2K	<1.5K	3K	<1.5K	2K	<1.5K	4K
	M4 50/250C ⁽¹⁾	<1K	3K	<1K	3.5K	<1K	3K	<1K	4K
	M4 150/550C	<1K	3.5K	<1K	4.5K	<1K	3.5K	<1K	5.5K
	M5 400/1300C	<1K	0.35%K	<1K	0.7%K ⁽²⁾	<1K	0.35%K	<1K	0.75%K ⁽²⁾
	M5 1000/2500C	<1K	0.5%K	<1K	0.6%K	<1K	0.5%K	<1K	0.65%K
	M6 0/300C	<1K	2K	<1K	0.3%+2.5K	<1K	2K	<1K	0.4%+2.5K
	M6 100/700C	<1K	2K	<1K	0.3%+2.5K	<1K	2K	<1K	0.4%+2.5K
	M7 25/375C ⁽¹⁾	<1.5K	2K	<1.5K	3K	<1.5K	2K	<1.5K	4K
	M8 0/1000C	<1K	3.5K	<1K	4.5K	<1K	3.5K	<1K	5.5K
	R1 600/1600C	<1K	0.45%K	<1K	0.7%K	<1K	0.45%K	<1K	0.75%K
	R1 1000/2600C	<2K	0.75%K	<2K	1.1%K	<2K	0.75%K	<2K	1.2%K

⁽¹⁾ Above 75°C ⁽²⁾ Optimised for glass toughening = 3K at 630°C
 * For a definition of 'Repeatability' and 'Accuracy', refer to Land document 'NDA 478'
 ** Systems are functional, but performance is unspecified at emissivity values <0.200.

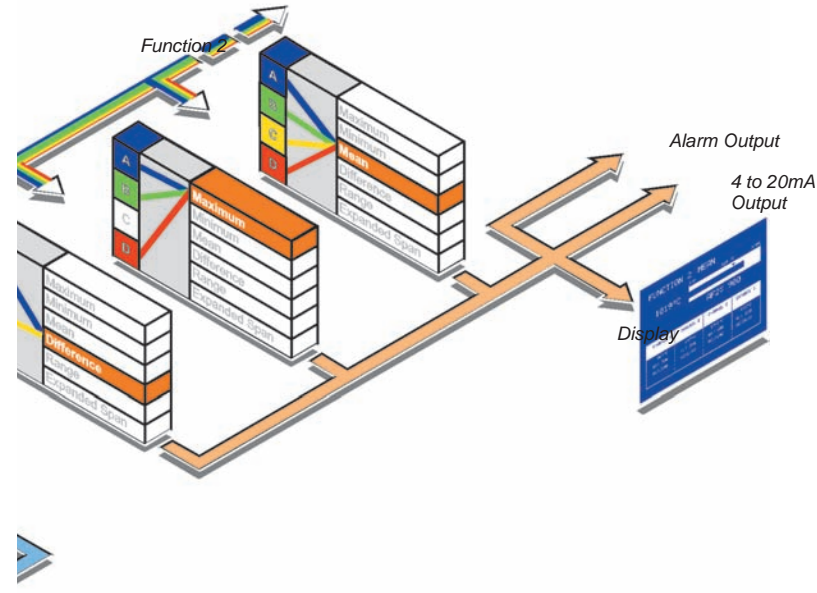

MULTI-CHANNEL CAPABILITY

The Multi-channel version of the **LANDMARK® GRAPHIC** processor provides up to four fully featured and independent temperature measurement systems in one package.

Any **SYSTEM 4** Thermometer can be connected to any input channel of the processor. Each channel is fully independent of the other, the inputs are *not* multiplexed. Additional channels may be added as required without affecting existing settings.

The processor can control all types of **SYSTEM 4** thermometer simultaneously (i.e. M1, R1, M6 etc.). The thermometers can have differing temperature ranges and even units (°C or °F).

Each channel has identical features to the single channel version; two analog outputs; a fully scaleable 0 to 20 or 4 to 20mA output, and a 1mV/° output. Two alarm outputs, both either High or Low activated, each with changeover relay, are provided on every channel card.

MATH FUNCTIONS

The unique multi-channel capability of the **LANDMARK® GRAPHIC** makes possible the, also unique, Math Function option. The processor accepts and compares up to four thermometer signals. The results are then output to the process control instruments in the form most suited to their requirements.

Two independent math functions are provided, each can calculate, display and output either the *Maximum*, *Minimum*, *Mean*, *Difference* or *Range* of temperatures measured by the selected thermometers in your system.

The *Expanded Span* function allows you to extend the span of your temperature measurement system from the minimum temperature of the thermometer with the lowest temperature range, to the maximum temperature of the thermometer with the highest temperature range.

Any **SYSTEM 4** Thermometer can be used in conjunction with the Math Functions. Up to *four* **SYSTEM 4** Thermometers can be connected to the processor and *two* Maths Functions can be configured. There are many different options for each Math Function, the same option can be selected for both functions if required.

Each Math Function is fully independent from the other, and both are independent from the four individual thermometer temperature output channels, standard to the Landmark Graphic Processor. Each function has both a current output, either 0 to 20mA or 4 to 20mA, and a single relay alarm output.

Math Functions have an almost unlimited range of uses in applications such as trending, cross-product uniformity, hot edge detection etc.

SERIAL COMMUNICATIONS

RS232C and RS485 serial communications are included with the Math Function option for the **LANDMARK® GRAPHIC** processor. A serial option is also available for users who do not require Math Functions.

Serial communications provide a remote interface between the processor and the process control computer. The serial communications circuitry connects directly to the internal microprocessor, via which it has access to all the data in the

LANDMARK® GRAPHIC.

A single option card can input any parameter for any fitted channel card, and retrieve all existing settings along with the temperature data and system status information for any fitted channel card.

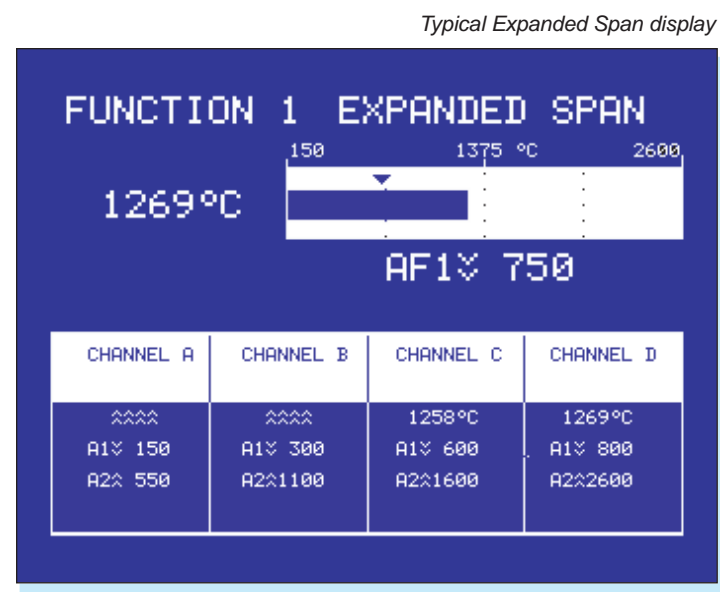

GRAPHIC

EASY CONFIGURATION

LANDMARK® GRAPHIC is easy to configure using the text based, setup menu system which is switch selectable in different languages; English, French, German, Italian, Spanish and Japanese. Once the thermometer type has been entered, the processor automatically configures the appropriate input data.

You can then select the required temperature span for the output current range, target emissivity/non greyness values and a range of time functions and alarm settings to match your exact needs.

All parameter settings are entry code protected.

Customer connections are also made as easy as possible, using two-part demountable terminal strips located on the rear panel. The modular construction of **SYSTEM 4** ensures that any system expansion is catered for with ease.

GRAPHICAL DISPLAY AND KEYPAD

The LCD panel features a large 320 x 240 pixel display, providing a high quality visual interface with the system.

The tactile keypad enables easy configuration of the processor with thermometer and process variables.

Help and error messages simplify setup and operation.

The cold cathode back-lit LCD panel provides a display of measured temperature in numeric or graphic formats, presenting useful profile or trending data. The LCD panel provides a choice of numeric, line chart, deviation chart or mixed displays.

Inputs from up to four individual thermometers can be displayed simultaneously as 4 channel numeric, 4 channel bar graph or 4 channel deviation bar graph.

REAL TIME PROCESSING

A fully featured and real time **Peak Picker** is used when measuring the temperature of intermittent targets, or where the hot target surface is obscured by cool areas such as scale on rolled steel.

Fast input sampling by the **Peak Picker**, combined with a built-in spike protection filter allows the processor to respond quickly to a rise in temperature signal from the thermometer.

The user settings also includes a threshold value which, together with On/Off delay timers and two distinct modes of operation, allow configuration to deal with the most demanding of applications.

An **Averager** is used to smooth any rapid fluctuations in the process value or reading to deliver a stable, time-averaged value for process control.

The time constant is selected from 0 to 512 seconds, to give suitable, gradual changes in the temperature display and processor output.

If your process is intermittent or interrupted, a **Track and Hold** function is provided which allows you, via an external command signal, to **Hold** the required measurement value until you wish to once again **Track** the variations in the process.

ALARMS

Two alarms are provided, selectable as either high or low, and are ideal for use as ON/OFF controllers. Alarm thresholds are selectable in 1° steps within the temperature of the thermometer.



Landmark® Graphic Processor display and keypad

Typical Landmark® Graphic Displays

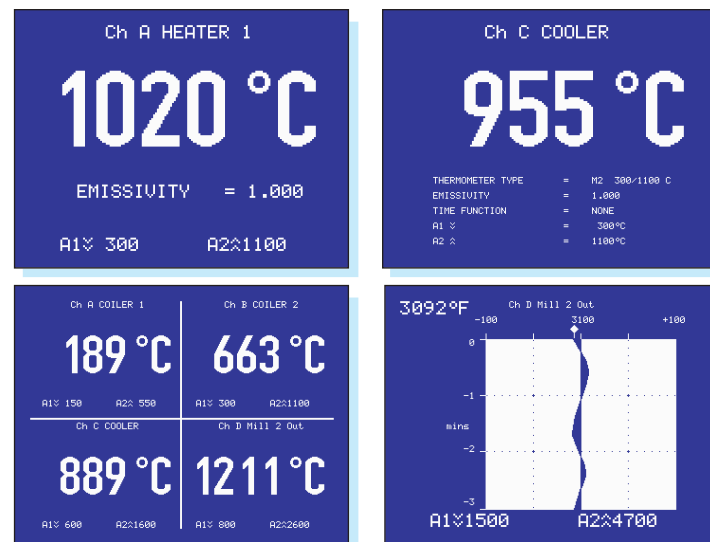

BASIC

LANDMARK® BASIC is a simple, low cost, DIN-rail mounted signal processing unit, providing economic conditioning of any System 4 thermometer output signal - ideal for both end user and OEMs.

- Standard DIN-rail mounting - requires no panel space
- Time functions - average and peak picker as standard
- Provides easy access to your thermometer's emissivity/non-greyness control
- Digital panel meter with alarm is available (LMi)
- Industry standard 4 to 20mA output to suit all industries and control systems

LANDMARK® BASIC has standard electrical outputs and DIN-rail hardware, designed to allow easy integration into OEM's and end user process control systems.

LANDMARK® BASIC enables adjustment of emissivity/non-greyness and time functions from your control room - not out on your sensor.

LANDMARK® BASIC signal processing features an adjustable averager and peak picker with remote reset.

REAL TIME PROCESSING

The **Averager** function is used to smooth unwanted variations or rapidly fluctuating changes in the measured signal.

The **Averager** time constant can be adjusted, via the control mounted on the front of the **BASIC** processor, from 175ms to 4s (10 to 90%).

The **Peak Picker** function is used when measuring the temperature of intermittent targets or where the hot target surface is obscured by cool areas. The **Peak Picker** decay rate is adjustable from 1 to 5000% of span per second. A remote reset function is provided from voltage free relay or switch contacts.

POWER SUPPLY

The **DPU** power supply unit provides the power supply (30V d.c. nominal) which the **LANDMARK® BASIC** processor requires. The **DPU** can be DIN-rail mounted alongside the **LANDMARK® BASIC**. Several models are available to cover all input voltages.

LANDMARK® INDICATOR

The **LMi** is an easy to read digital panel meter providing continuous indication of measured temperature.

Up to two alarms (high or low) may be set, providing a voltage free relay output. A visual display on the front panel indicates when an alarm has been tripped. Alarm thresholds are set via the front panel.

It also provides scaleable 4 to 20mA output to match the input range of your process control system.



Landmark Basic Processor and DPU Power Unit

Landmark Basic Processor and DPU connections

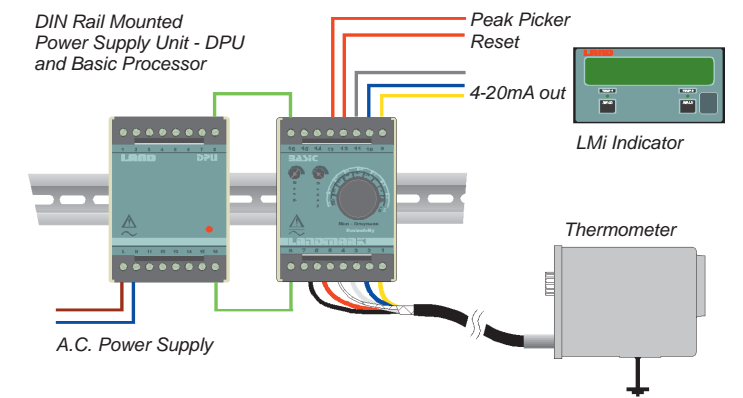

Landmark Basic Processor controls



LANDMARK® TECHNIC is a high precision, digital, DIN-rail mounted signal processing unit, providing economic conditioning of any System 4 thermometer output signal - ideal for both end user and OEMs.

- Standard DIN-rail mounting - requires no panel space
- Time functions - average, peak picker and track and hold as standard
- Industry standard 4 to 20mA output
- Remote input for Track and Hold
- Emissivity/non-greyness adjustment
- Alarm output
- Set up performed using a PC and configuration software
- Indicator (LMi) and power supply are also available

LANDMARK® TECHNIC has standard electrical outputs and is DIN-rail mounted for easy integration into OEM's and end user process control systems.

RS232C serial communications are included providing a remote interface between the processor and a PC for configuring the system parameters.

REAL TIME PROCESSING

The **Averager** function is used to smooth unwanted variations or rapidly fluctuating changes in the measured signal. The Averager time constant can be adjusted from 50ms to 512s (63%) in 15 steps.

The **Peak Picker** function is used when measuring the temperature of intermittent targets or where the hot target surface is obscured by cool areas. The **Peak Picker** decay rate is adjustable from 0.25%/s to 512%/s in 12 steps.

The **Track and Hold** function is also provided with remote reset via voltage free relay or switch contacts.

POWER SUPPLY

The **DPU** power supply unit provides the power supply (30V d.c. nominal) which the **LANDMARK® TECHNIC** processor requires. The **DPU** can be DIN-rail mounted alongside the **LANDMARK® TECHNIC**. Several models are available to cover all input voltages.

LANDMARK® INDICATOR

The **LMi** is an easy to read digital panel meter providing continuous indication of measured temperature. Up to two alarms (high or low) may be set, providing a voltage free relay output. A visual display on the front panel indicates when an alarm has been tripped. Alarm thresholds are set via the front panel.

It also provides scaleable 4 to 20mA output to match the input range of your process control system.

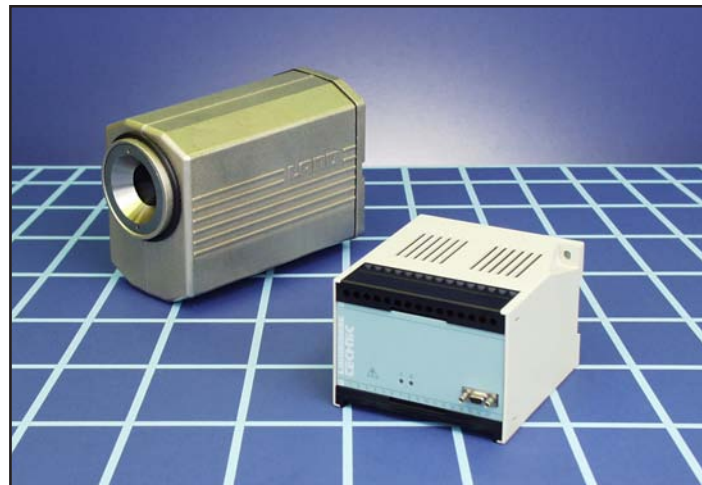

Landmark Technic Processor and System 4 thermometer



Landmark Technic Processor connections

CONFIGURATION

The temperature measurement system is readily configured using the LM Technic Configuration Software and a PC.

The PC is connected to the RS232C port on the LM Technic front panel to perform the configuration.

Once configured, the PC is disconnected from the LM Technic and the LM Technic can be left to operate. The system configuration is stored in non volatile memory.

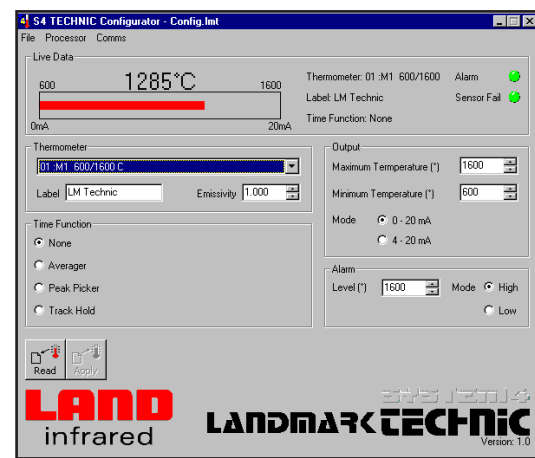

Multi-Channel Bar Chart Display

ORDERING INFORMATION

LANDMARK® GRAPHIC has a unique model number which describes the processor model. The model number, consisting of the various options available, can be used for selection and ordering purposes (see below).

MULTI-CHANNEL PROCESSOR

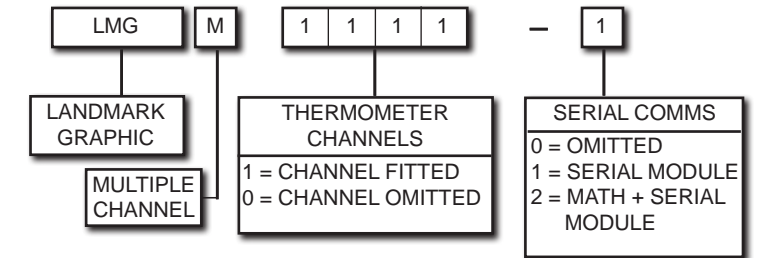

For example: LMG - M 1 1 1 1 - 1 is a **LANDMARK® GRAPHIC** configured with four thermometer input cards with serial communications.

ENVIRONMENTAL PROTECTION

The processor case is constructed from high quality extruded aluminium with a die cast bezel. An optional, clear, moulded cover panel is available. The cover panel, designed to the requirements of IP65/NEMA 4 is removable and provides environmental protection in hostile locations.

Landmark Graphic Processor fitted with cover panel



CLASSIC

The Landmark® Classic is a simple, reliable thermometer signal processing unit, with many optional features, intended for cost conscious temperature monitoring and control applications.

- Rugged flexible modular design
- Proven, reliable electronics
- Optional time function and alarm modules
- Industry standard 4 to 20mA output to suit all industries and control systems

LANDMARK® CLASSIC is a modular, flexible processor, fully compatible with the entire range of **SYSTEM 4** thermometers.

The processor provides the necessary power and control signals required by the thermometer for either emissivity or non greyness compensation. It has an LCD display of temperature and parameter variables.

The processor accepts the input signal from the **SYSTEM 4** thermometer, provides a display of temperature and retransmits the signal as an industry standard 4 to 20mA output either directly to your process control system, or via optional time function and alarm modules.

LANDMARK® CLASSIC can be configured with either a peak picker or averager time function, and up to two alarm modules which may be selected at the time of purchase or retrofitted in the field. There is no requirement for recalibration on subsequent change of options installed.

The modular design of **LANDMARK® CLASSIC** gives you maximum flexibility on the choice of processing requirements for your application.

This ensures that your temperature measurement system can be adapted to suit all applications, whatever the specific requirements.

EASY CONFIGURATION

Configuration is simple and quick. The measurement range is scaled to suit the particular type of thermometer in use via span and offset controls on the front panel. Built-in reference sources enable processor calibration without any external test equipment. Switches are provided for thermometer series, units (°C or °F) and emissivity or non greyness.



Landmark Classic Processor fitted with Alarms and Peak Picker function



Landmark Classic Processor fitted with cover panel



DISPLAY

The large, easy to read LCD panel provides a continuous display of measured temperature, together with over and under range indications.

Alarm and emissivity or non-greyness settings are displayed at the press of a button.

REAL TIME PROCESSING

A fully featured and real time **Peak Picker** is used when measuring the temperature of intermittent targets, or where the hot target surface is obscured by cool areas such as scale on rolled steel.

Fast input sampling by the **Peak Picker**, combined with a built-in spike protection filter allows the processor to respond quickly to a rise in temperature signal from the thermometer.

The **Peak Picker** has a user adjustable decay rate and both manual and remote reset controls, giving flexibility to deal with the most demanding of applications.

An **Averager** is used to smooth any rapid fluctuations in the process value or reading to deliver a stable, time-averaged value for process control.

The time constant is selected from 0 to 512 seconds, to give suitable, gradual changes in the temperature display and processor output.

ALARMS

Two alarms are provided, selectable as either high or low, and are ideal for use as ON/OFF controllers. Alarm thresholds are adjustable in 1° steps within the temperature of the thermometer.

ENVIRONMENTAL PROTECTION

The processor case is constructed from high quality extruded aluminium with a die cast bezel. An optional, clear, moulded door panel is available. The door panel, designed to the requirements of IP65/NEMA 4, is removable and provides environmental protection in hostile locations, as well as a degree of tamper proofing.

ORDERING INFORMATION

LANDMARK® CLASSIC has a unique model number which describes the processor model. The model number, consisting of the various options available, can be used for selection and ordering purposes.

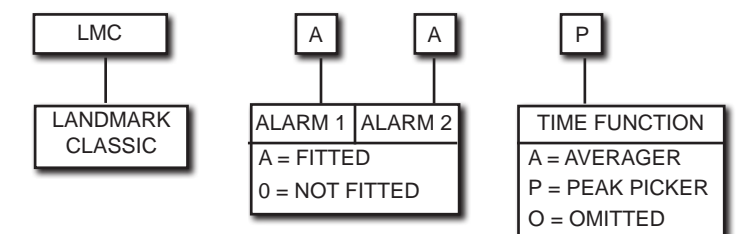

For example: LMC-A-A-P is a **LANDMARK® CLASSIC** processor with alarms 1 and 2, and peak picker modules fitted.