



# HGM-RD

## Remote Display Module: Refrigerant Gas Monitoring System

### Instruction 3015-5157

Installation / Operation / Maintenance

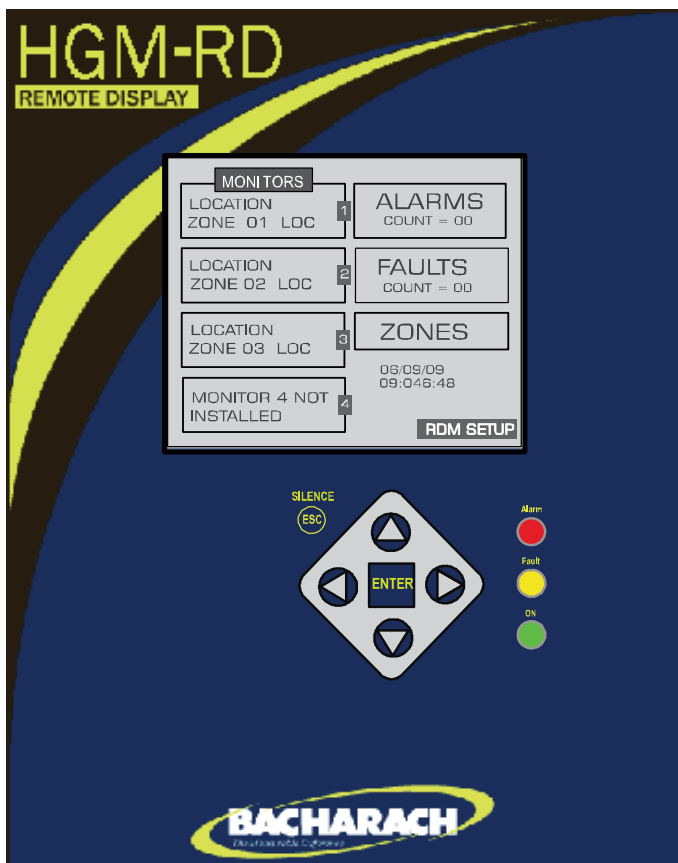

UL 61010-1  
CSA 22.2 No. 1010.1

Rev. A – Preliminary- January, 2009

Product Leadership • Training • Service • Reliability

## WARRANTY

Bacharach, Inc. warrants to Buyer that at the time of delivery this Product will be free from defects in material and manufacture and will conform substantially to Bacharach Inc.'s applicable specifications. Bacharach's liability and Buyer's remedy under this warranty are limited to the repair or replacement, at Bacharach's option, of this Product or parts thereof returned to Seller at the factory of manufacture and shown to Bacharach Inc.'s reasonable satisfaction to have been defective; provided that written notice of the defect shall have been given by Buyer to Bacharach Inc. within two (2) years after the date of delivery of this Product by Bacharach, Inc.

Bacharach, Inc. warrants to Buyer that it will convey good title to this Product. Bacharach's liability and Buyer's remedy under this warranty of title are limited to the removal of any title defects or, at the election of Bacharach, to the replacement of this Product or parts thereof that are defective in title.

The warranty set forth in Paragraph 1 does not apply to parts the Operating Instructions designate as having a limited shelf-life or as being expended in normal use (e.g., filters).

THE FOREGOING WARRANTIES ARE EXCLUSIVE AND ARE GIVEN AND ACCEPTED IN LIEU OF (I) ANY AND ALL OTHER WARRANTIES, EXPRESS OR IMPLIED, INCLUDING WITHOUT LIMITATION THE IMPLIED WARRANTIES OF MERCHANTABILITY AND FITNESS FOR A PARTICULAR PURPOSE; AND (II) ANY OBLIGATION, LIABILITY, RIGHT, CLAIM OR REMEDY IN CONTRACT OR TORT, WHETHER OR NOT ARISING FROM BACHARACH'S NEGLIGENCE, ACTUAL OR IMPLIED. The remedies of the Buyer shall be limited to those provided herein to the exclusion of any and all other remedies including, without limitation incidental or consequential damages. No agreement varying or extending the foregoing warranties, remedies or this limitation will be binding upon Bacharach, Inc. unless in writing, signed by a duly authorized officer of Bacharach.

**Register your warranty by visiting  
[www.bacharach-inc.com](http://www.bacharach-inc.com)**

---

### Declaration of Conformity

Manufacturer's name:	Bacharach, Inc.
Manufacturer's address:	621 Hunt Valley Circle New Kensington, PA 15068
Product Name:	HGM-RD (Refrigerant Gas Monitoring System) European EMC Directive 2004/108/EC EN55011 – Emissions Product Specific Standard EN61326-1 – Immunity Product Specific Standard EN61010-1 – Safety requirements for Electrical Equipment For Measurement, Control, and Laboratory Use-Part 1: General Requirements

---

### Notice:

Product improvements and enhancements are continuous; therefore the specifications and information contained in this document may change without notice.

Bacharach, Inc. shall not be liable for errors contained herein or for incidental or consequential damages in connection with the furnishing, performance, or use of this material.

No part of this document may be photocopied, reproduced, or translated to another language without the prior written consent of Bacharach, Inc.

Copyright © 2000–2008, Bacharach, Inc., All Rights Reserved

BACHARACH® is a registered trademark of Bacharach, Inc. All other trademarks, trade names, service marks and logos referenced herein belong to their respective owners.

# Table of Contents

---

<b>1 Introduction.....</b>	<b>5</b>
How to Use This Manual.....	5
Warning Statements .....	5
Caution Statements .....	5
Hazard Symbols on the Monitor.....	5
Safety Precautions.....	6
AC Power Supply .....	6
Protective Grounding.....	6
Explosive Atmosphere.....	6
Proper Exhaust Venting .....	6
Accessing the Interior of the Monitor.....	6
Misuse and Modifications to the Monitor.....	6
In Case of Malfunction.....	6
Installation Category.....	6
Altitude Limit.....	6
Cleaning .....	6
Functional Overview .....	7
General Description.....	7
Communication Options.....	7
Understanding Monitoring Levels.....	7
Suggested Location of Sampling Points .....	7
Response to the Presence of Multiple Refrigerants.....	8
<b>2 Installation.....</b>	<b>9</b>
Installation Considerations.....	10
Warnings and Cautions.....	10
Inspection .....	10
Location of the Monitor.....	10
Mounting Instructions.....	11
Interior Schematic.....	12
Electrical Wiring .....	13
Communication Connections.....	14
HGM-MZ Network .....	14
Integration with Building Management System.....	14
Changing Terminator Switch Settings .....	15
Connecting External Alarms .....	16
Overview .....	16
Connection .....	16
<b>3 Operation.....</b>	<b>17</b>
HGM-Remote Display .....	17
Internal Audible Alarm.....	17
External Alarms .....	17
Screen Displays.....	18
System Programming .....	18
Setup Parameters .....	18
Password Protection .....	18
Setup Programming.....	19

Setting the Clock .....	19
Navigating to the 1 <sup>st</sup> RDM Setup Screen .....	19
Number of HGM Units .....	20
HGM Baud Rate .....	20
Audible Alarm .....	20
Enabling Building Management System Connection .....	20
Building Management System Baud Rate .....	20
Password .....	20
Navigating to the 2 <sup>nd</sup> RDM Setup Screen.....	21
Setting Relay Parameters .....	21
HGM Node Address .....	21
Navigating to the 1 <sup>st</sup> and then 2 <sup>nd</sup> HGM Setup Screen .....	22
Location .....	22
Number of Zones Installed .....	22
Alarm Ack Mode .....	23
Audible Alarm .....	23
Zone Hold Time .....	23
Detection Limit.....	23
Loop2 Factor .....	23
Re-Zero Mode .....	24
Navigating to the 3 <sup>rd</sup> HGM Setup Screen .....	24
Service Timeout .....	24
<b>Zone Setup Programming.....</b>	<b>25</b>
Navigating to the 1 <sup>st</sup> Zone Setup Screen .....	25
Location .....	25
Refrigerant.....	26
Distance .....	26
Average Temperature .....	26
Current PPM.....	26
Log Interval.....	26
Navigating to the 2 <sup>nd</sup> Zone Setup Screen.....	26
Leak Level .....	27
Spill Level .....	27
Evacuation Level .....	27
Re-Setting the Peak PPM Value .....	27
Navigating to the Trend Screen .....	28
<b>4 General Operation .....</b>	<b>29</b>
Functional Overview.....	29
The Zone Screen.....	29
Alarm Conditions .....	30
Fault Conditions .....	30
The System Screen.....	31
Alarm Conditions .....	31
Alarm Log .....	32
<i>Fault Conditions</i> .....	33
Alarms .....	34
Functional Overview.....	34

Responding to Alarms .....	34
Alarm Detail Screen .....	35
Acknowledging Alarms .....	36
The Trend Screen .....	37
Overview - Log Interval .....	37
System Faults .....	38
Functional Overview .....	38
CRITICAL FAULTS .....	38
NON CRITICAL FAULTS .....	39
Reset to Factory Default Settings .....	39
Clearing System Faults .....	40
Viewing Fault Log .....	40
The Calibration Screen .....	41
Overview .....	41
Adjusting Calibration Factor .....	41
Calibration Procedure on Main Monitor .....	42
Programming New Gasses .....	42
Overview .....	43
Diagnostic Screen Overview .....	44
Service Mode .....	45
<b>5 Maintenance .....</b>	<b>46</b>
Servicing Air Lines & Termination Filters .....	46
<b>Appendix .....</b>	<b>47</b>
Logic Diagram .....	47
Recommended Alarm Settings .....	48
RS-485 Communication Protocol .....	49
Overview .....	49
MODBUS RTU Protocol .....	49
HGM-MZ MODBUS RTU Operation .....	50
Overview .....	50
Protocol Details .....	50
Notes on HGM-MZ Polling .....	50
Notes on Network Topologies .....	50
Key Comm Protocol Parameters .....	51
Summary of Registers .....	52
Status Register .....	54
Zone Data .....	55
Cal Data Register .....	57
Date Time Register .....	57
Sensor Data Register .....	58
Release Zone Hold Register .....	59
Hold Zone Register .....	59
HGM-300 Hold Mode .....	59
Fault Log Register .....	60
Alarm Log Register .....	60
Service Mode Register .....	61

Release Service Mode Register .....	61
HGM-300 Service Mode.....	61
PPM Register.....	62
Zone Log Registers .....	62
MODBUS EXCEPTION RESPONSES .....	62
<b>Specifications .....</b>	<b>63</b>

# 1 Introduction

## ***How to Use This Manual***

Thank you for investing in a Bacharach HGM-RD Refrigerant Gas Remote Display Module.

To assure operator safety and the proper use of the HGM-RD please read, understand, and follow the contents of this manual, which provides important information on the installation, operation, and maintenance of the monitor.

If you have a working knowledge of refrigerant monitors, you will find this manual useful as a reference tool. If you are new to the use of refrigerant monitors, you can educate yourself about the principles of refrigerant gas detection and the proper operation of this device by reading this manual thoroughly.

This manual provides important information on how to install, operate, and service the HGM-RD Display Module.

## ***Warning Statements***

The use of the word **WARNING** in this manual denotes a potential hazard associated with the use of this equipment. It calls attention to a procedure, practice, condition, or the like, which if not correctly performed or adhered to, could result in personal injury or death.

## ***Caution Statements***

The use of the word **CAUTION** in this manual denotes a potential hazard associated with the use of this equipment. It calls attention to a procedure, practice, condition, or the like, which if not correctly performed or adhered to, could result in damage to the equipment.

### **Hazard Symbols on the Monitor**



This symbol indicates the need to consult this operating instruction manual when opening the enclosure.

**WARNING:** *A potential risk exists if the operating instructions are not followed.*



This symbol indicates the presence of electric shock hazards when the enclosure is opened.

**WARNING:** *To avoid risk of injury from electric shock, do not open the enclosure without first disconnecting AC power.*

## ***Safety Precautions***

### **AC Power Supply**

The HGM-RD uses a universal power supply that is capable of accepting inputs of 100 to 240 VAC, 50/60 Hz. Ensure the source voltage matches the voltage of the product before energizing the equipment. It is highly suggested that the HGM-RD be placed on its own circuit with UPS or surge protection.

### **Protective Grounding**

Under no circumstances should the HGM-RD be operated without connection to a protective ground. Doing so poses a potential shock hazard and is also a violation of electrical safety standards applicable to this type of equipment.

### **Explosive Atmosphere**

Do not operate this equipment in the presence of flammable liquids, vapors or aerosols. Operation of any electrical instrument in such an environment constitutes a safety hazard.

### **Proper Exhaust Venting**

It is imperative that the exhaust port on this instrument be properly vented as described in this manual. Failure to do so may constitute a safety hazard.

### **Accessing the Interior of the Monitor**

Extreme care should be exercised when accessing the interior of the monitor. Only qualified electrical maintenance personnel should perform connections and adjustments. Always remove AC power before working inside the monitor.

### **Misuse and Modifications to the Monitor**

The protection provided by the monitor may be impaired if the monitor is used in a manner not specified by Bacharach, Inc. Modifications to this monitor, not expressly approved, will void the warranty.

### **In Case of Malfunction**

Do not continue to use this equipment if there are any symptoms of malfunction or failure. In the case of such occurrence, de-energize the power supply and contact a qualified repair technician or the nearest Bacharach Service Center. Use ONLY the provided knockouts for electrical and communication wiring. Drilling into the box will void the warranty.

### **Installation Category**

Installation Category II, Pollution Degree II, as defined by UL.

### **Altitude Limit**

6,562 ft (2,000 m)

### **Cleaning**

To clean the outside of the case use a **DRY CLOTH**. **DO NOT** use soap and water.

## Functional Overview

### General Description

Refrigerant monitors are specified to support compliance to federal, state and local safety codes governing refrigerant emissions. Avoiding significant refrigerant loss reduces equipment replacement costs, maintains equipment efficiency, promotes safety, and protects the environment.

An audible alarm and front panel indicators are provided to signal alarm and fault conditions, and relay contacts are provided that can be used to trigger external alarm devices in the event of a system fault, or if a leak (small), spill (medium), or evacuation (large) level of gas is detected.

The HGM-RD requires only minor periodic maintenance such as the occasional replacement of filters. The monitor incorporates active diagnostics that continuously check the system for proper operation. A front panel indicator is provided to alert an operator of system malfunctions, and fault codes are generated that enable the user to identify the cause of the fault.

### Communication Options

The HGM-RD features full two-way communications via an RS-485 interface. MODBUS RTU is the communication protocol standard. The instrument can be connected to a Building Management System or it may be operated as a stand-alone system with Bacharach's HGM-MZ (P/N 3015-5074).

Please refer to the Appendix for a more complete discussion of communication protocols.

### Understanding Monitoring Levels

Effective use of this instrument requires an understanding of what constitutes reasonable alarm set points for the types of gasses being monitored. Refrigerant manufacturers define allowable exposure levels and threshold limit values in units of parts per million (ppm). Bacharach has developed recommended monitoring levels based on compliance to ANSI/BSR ASHRAE 15-1994 and ASHRAE Safety Code 34-1992. These reference levels are listed in the Appendix.

Setting the unit at these recommended alarm levels will satisfy the needs of most users. However, the PPM levels generated by system leaks into the environment are greatly influenced by the volume of air in the sampling area, air circulation, size of the leak, distance to the monitoring point, and a host of other variables. In some cases the set points may need to be adjusted either up or down to achieve effective monitoring.

### Suggested Location of Sampling Points

At the point of a refrigerant leak the gas is nearly pure. As the refrigerant is dispersed into the air, the gas molecules diffuse causing a dilution of the original concentration. The HGM-MZ measures the refrigerant concentration at the precise point the sample is collected. Therefore, if the termination of the collection line is not at the exact point of the refrigerant leak, then the unit will read a diluted mixture of the refrigerant gas and air.

It should also be noted that refrigerant gas is heavier than air and tends to collect below the point of a leak. Therefore samples taken near the floor will have a greater concentration of gas than those collected above the source of a leak will. Consequently, sampling points should ideally be located as close as possible to the source of potential leaks. Line-end filters should be mounted 12" to 18" above the floor. If this is impractical, then the alarm set points should be adjusted for that zone to compensate for the dilution of the refrigerant gas. **DO NOT plug any of the zones.** Plugging a zone will give the monitor a false indication during start up.

The HGM-MZ should be centrally located in the mechanical room and be readily accessible for easy visual monitoring and servicing. Air sample tubing may be run in lengths up to **500 feet**. The fresh air purge line should draw from an area that does not contain any refrigerant gas and cannot exceed **300 feet** in length. The exhaust line should run to an out side location if possible. The length of the exhaust line cannot exceed **300 feet**.

Ideally, two to three pick up points spaced around each chiller will provide sufficient coverage. It may be necessary to perform a "smoke" test of the mechanical room to determine the best locations. The smoke test would provide the pattern of air currents present in the mechanical room.

### HGM-MZ / HGM-RD Refrigerant Gas leak Monitor Mechanical Room Placement

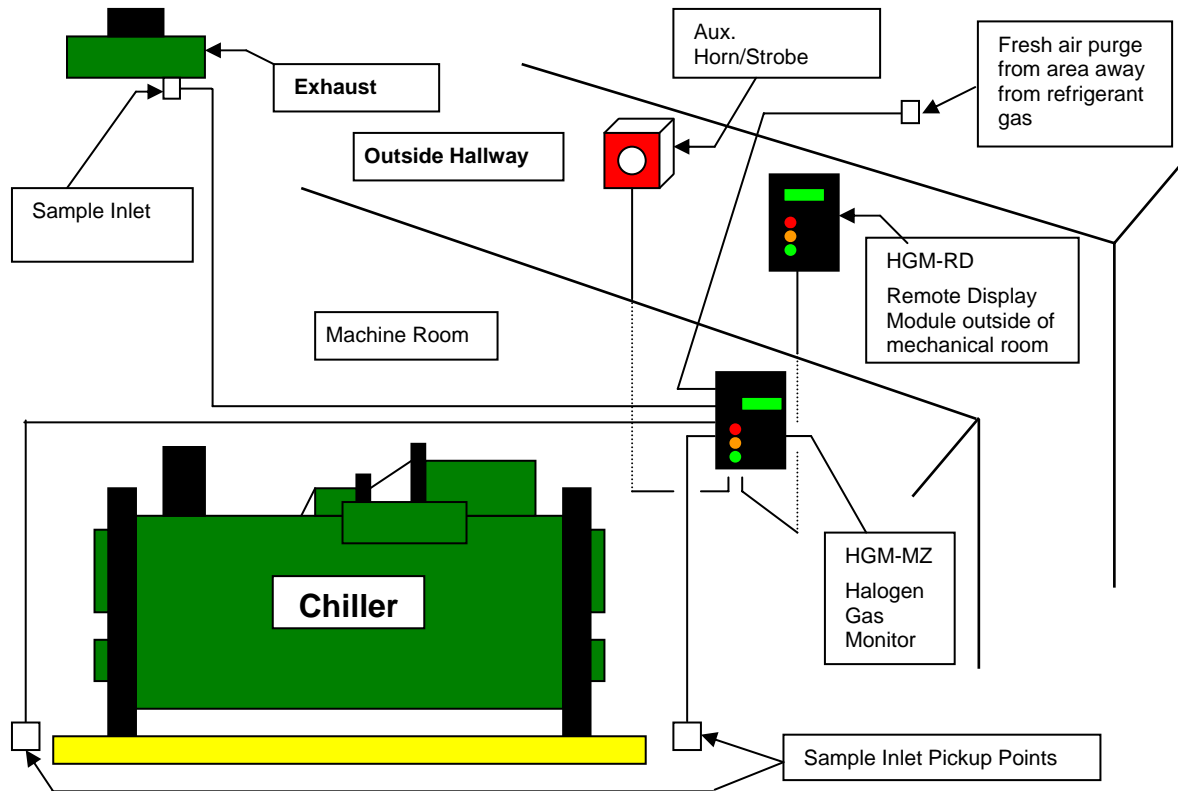

The HGM-RD should be mounted outside of the mechanical room or at least just inside of a door to the room. This is the “split architecture design” for safety of the operator. The HGM-RD can be located up to 4500 feet from the HGM-MZ. The HGM-RD is the man machine interface by which you program the HGM-MZ, acknowledge alarms and observe conditions inside of the mechanical room. Note that there are two additional alarm relay contacts in the HGM-RD that can be programmed to alarm with “leak, spill, evacuate, fault or monitor on”.

### Response to the Presence of Multiple Refrigerants

Technically speaking, the HGM-MZ is a refrigerant level monitor, not a gas analyzer. You must program the instrument to test for a specific refrigerant in each zone, and it will only return accurate concentration readings for that particular refrigerant. If a leak occurs of another refrigerant gas type, the instrument may return deceptive readings.

Most applications only require detection of a single refrigerant and the problems that are associated with monitoring multiple gasses are rarely an issue. If there is a possibility of multiple refrigerants leaking in the same sampling zone, you should consider carefully which refrigerant compound you program the instrument to monitor.

# 2 Installation

## HGM-RD Oblique Photo

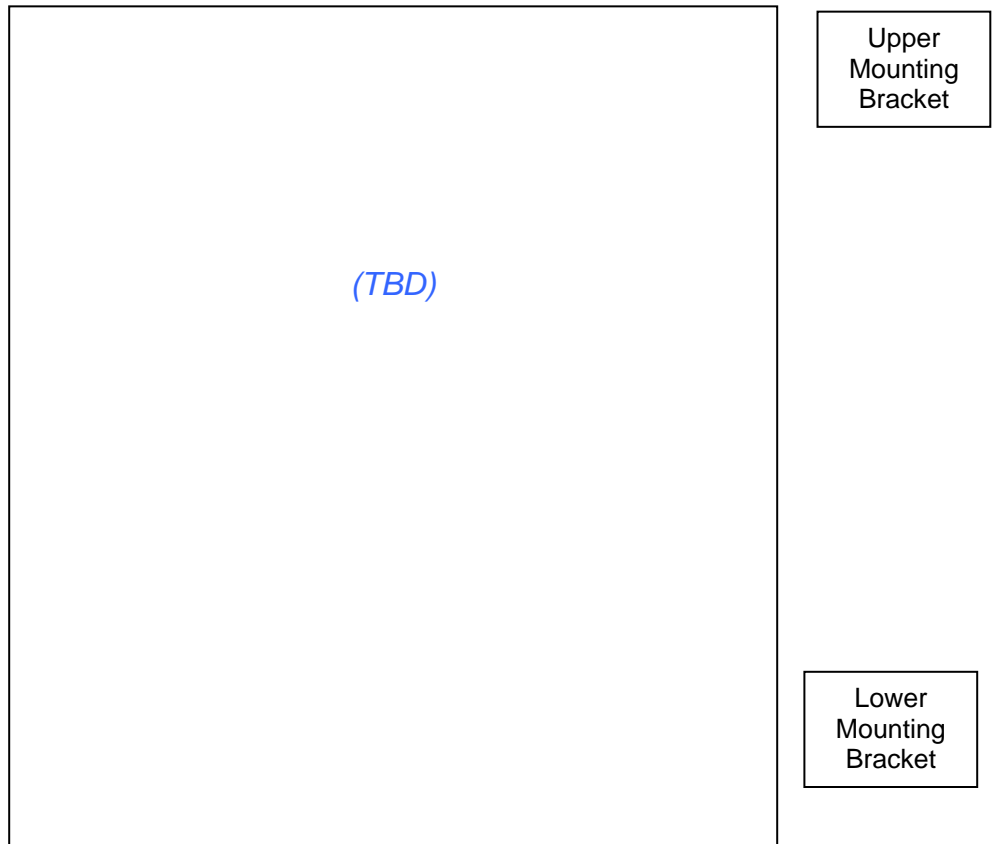

## ***Installation Considerations***



### **Warnings and Cautions**

**WARNING:** Electrical installation should be performed by a certified electrician, and should comply with all applicable NEC/CEC and local electrical safety codes.

**WARNING:** The AC power ground wire must first be connected to the monitor's ground stud. Under no circumstances should this monitor be operated without a protective ground. Doing so poses a potential shock hazard, and is also a violation of electrical safety standards applicable to this type of equipment.

**WARNING:** Explosion hazard! Do not mount the HGM-RD in an area that may contain flammable liquids, vapors or aerosols. Operation of any electrical equipment in such an environment constitutes a safety hazard.

**WARNING:** Shock hazard! Always disconnect AC power before working inside the monitor.

**CAUTION:** Drilling holes in the HGM-RD enclosure may damage the unit and will void the warranty. Please use provided knockouts for electrical connections.

**CAUTION:** The HGM-RD contains sensitive electronic components that can be easily damaged. Be careful not to touch or disturb any of these components.

## **Inspection**

The HGM-RD has been thoroughly inspected and tested prior to shipment from the factory. Nevertheless, it is recommended that the instrument be re-checked prior to installation. Inspect the outside of the enclosure to make sure there are no obvious signs of shipping damage. Loosen the four screws on the sides of the enclosure and remove the front panel. Visually inspect the interior of the display for loose components that may have become dislodged during shipment. If damage is discovered, please contact the nearest Bacharach Service Center for assistance.

## **Location of the Monitor**

The HGM-RD should be centrally located in the facility (preferably outside of the mechanical room) and should be easily accessible for visual monitoring and servicing. This is the "split architecture design" for safety of the operator.

Dirt, grease, and oils can adversely affect the operation of the HGM-RD. The monitor should be installed out of direct sunlight in a clean, dry area that is not subject to temperature or humidity extremes. Installation of the monitor in a mechanical room is acceptable provided reasonable environmental conditions exist. If there is a question, consider installing the unit outside of the mechanical room in a cleaner area of the facility.

The HGM-RD can be located up to 4500 feet from the furthest HGM-MZ. The HGM-RD is a man machine interface by which you can program the HGM-MZ, acknowledge alarms, and observe conditions inside the mechanical room. Note that there are two additional alarm relay contacts in the HGM-RD that can be programmed to alarm with "leak, spill, evacuate, fault or monitor on".

## Mounting Instructions

The HGM-RD should be installed plumb and level and securely fastened to a rigid mounting surface.

The enclosure utilizes keyhole mounting brackets designed for ¼ inch fasteners. Locate the four screws as shown in the diagram below or by using the provided mounting template. Allow the screw heads to protrude approximately 1/4".

### HGM-RD Mounting Specs

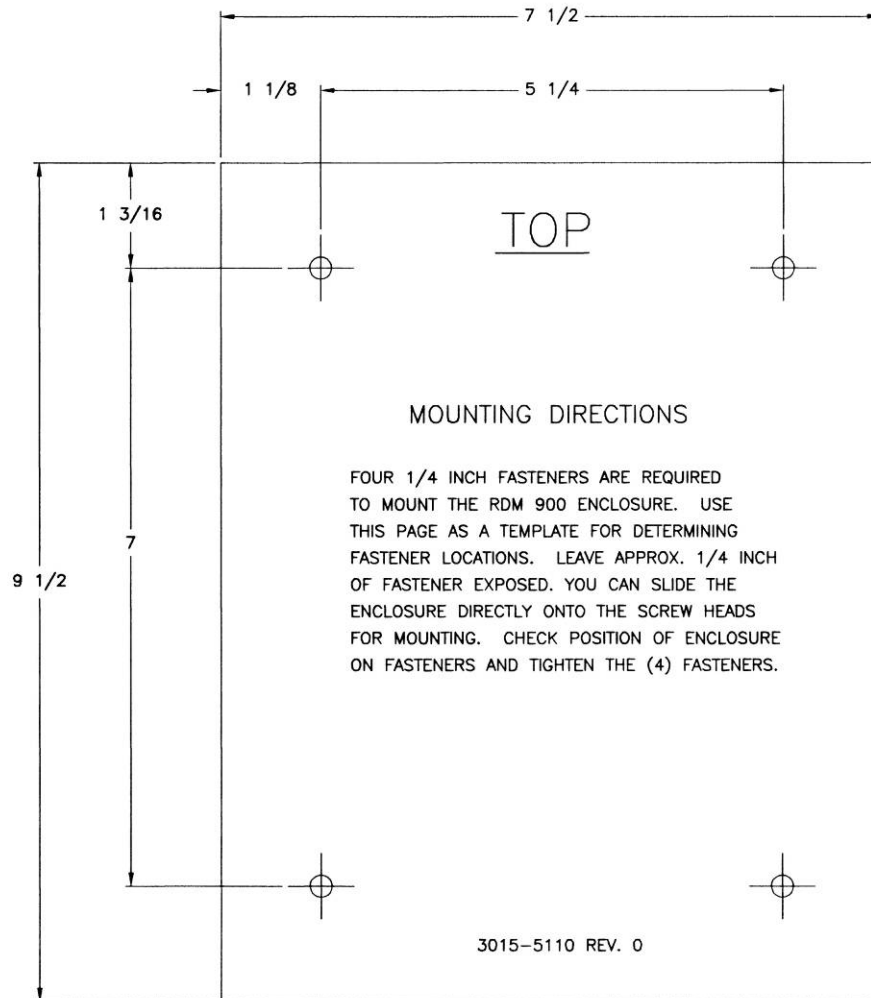

Hold the monitor flat against the mounting surface and allow it to slide down engaging the screw heads in the keyhole slots of the mounting brackets. Adjust the screws as necessary to hold the monitor securely against the mounting surface.

# Interior Schematic

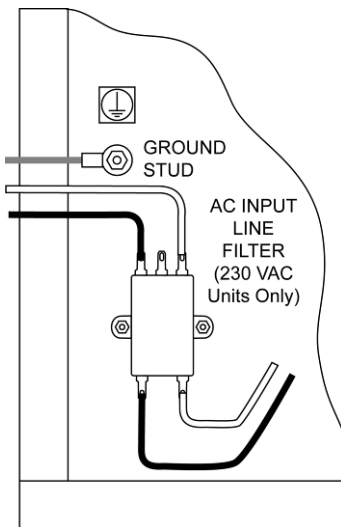
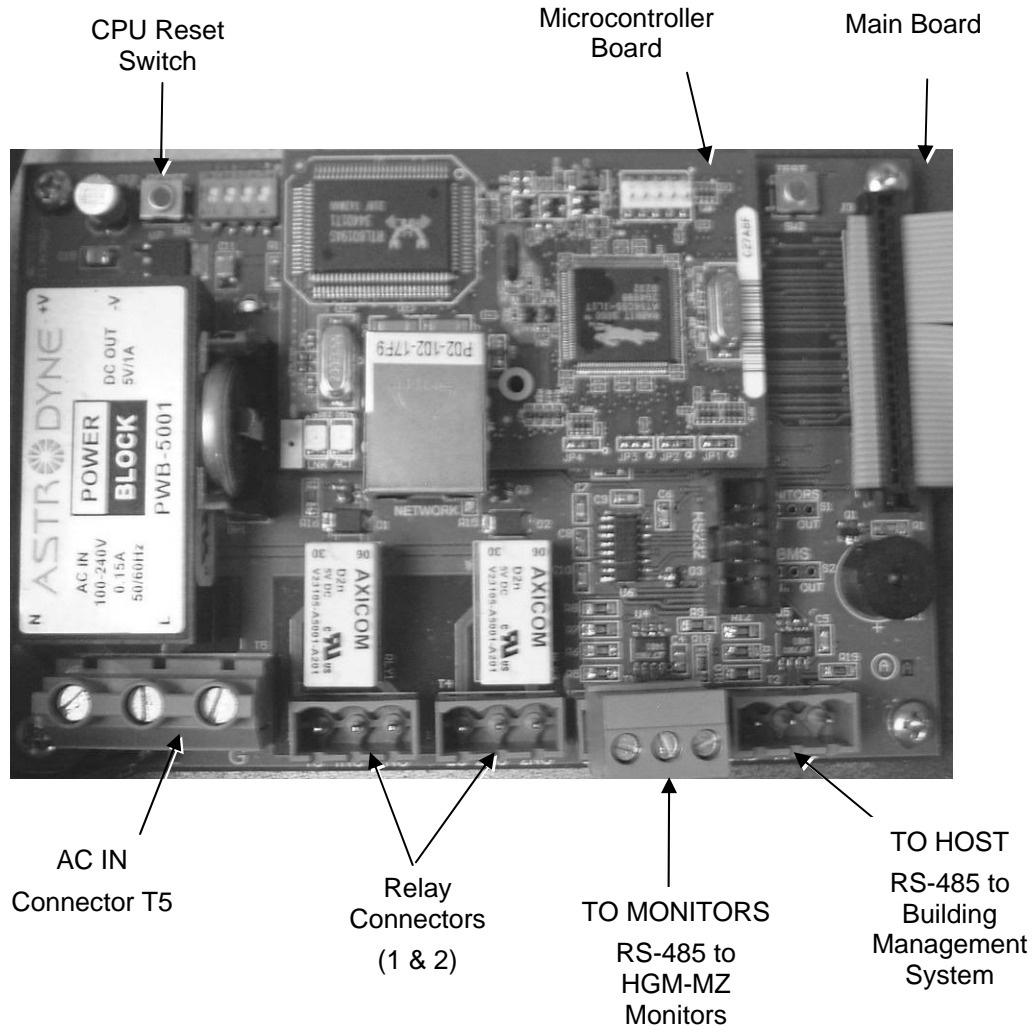

## Electrical Wiring

The HGM-RD uses a universal power supply that is capable of accepting inputs of 100 to 230 VAC, 50/60 Hz. The monitor's power consumption is 25 Watts. It is highly recommended that the monitor be connected directly to the AC power source, preferably on its own circuit. The AC power connection should be completed with UL approved 3-conductor wire (14–18 AWG), rated 300 VAC at 105°C.

Locate a convenient service knockout and install electrical conduit in the typical manner.

Locate the AC Input Terminals and Ground Stud on the inside of the monitor (Page 11). Secure the incoming AC power neutral (white/blue) and live (black/brown) wires to the LINE 1 and LINE 2 terminals.

Using the supplied crimp-on ring terminals, washers, and nuts, connect the incoming AC power ground wire (green) to the monitor's AC Input Ground Stud, and then install a separate wire between the ground stud and the GND terminal.



**WARNING:** Electrical installation should be performed by a certified electrician, and should comply with all applicable NEC/CEC and local electrical safety codes.

**WARNING:** Copper conductors for connection to supply mains must be made in accordance with NEC/CEC and local codes.

**WARNING:** The AC power ground wire must first be connected to the monitor's ground stud. Under no circumstances should this monitor be operated without a protective ground. Doing so poses a potential shock hazard, and is also a violation of electrical safety standards applicable to this type of equipment.

**CAUTION:** Drilling holes in the HGM-RD enclosure may damage the unit and will void the warranty. Please use knockouts provided for electrical connections.

A switch or circuit breaker rated 1.0 A, 250 VAC must be attached to the monitor's AC power leads. This switch must also be located in close proximity to the monitor, and be in easy reach of the operator. This switch should also be clearly marked as the monitor's main AC disconnect device.

### HGM-RD AC Input Power and Ground Connections

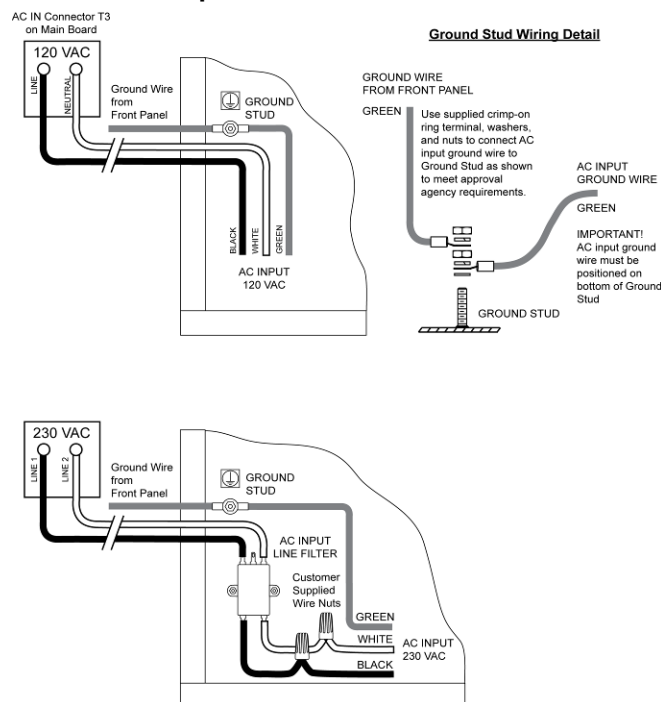

## Communication Connections

### HGM-MZ Network

The HGM-RD is connected to the HGM-MZ using a shielded twisted pair instrument cable. The maximum distance between the furthest away HGM-MZ and HGM-RD is 4500 feet.

Use any of the remaining service knockouts to gain access to the interior of the monitor. The RS-485 communication wiring between the HGM-MZ and HGM-RD must be connected in the following manner:

Locate the RS-485 connector in the HGM-MZ (Page 16 of HGM-MZ manual 3015-5074). Connect one lead of a twisted shielded pair to the “B” connection point (the far right point), note the wire color. Connect the second wire to the “A” connection point (the middle), note the wire color. Connect the ground to the “GND” connection point

Locate the RS-485 connector marked “TO MONITORS” in the HGM-RD (Page 12). This connector is located on the bottom of the HGM-RD PC board, second from the right. Make the wire run to the HGM-RD and connect the twisted shielded pair to the RS-485 TO MONITORS connector using the same color code as used on the HGM-MZ.

### Integration with Building Management System

A second RS-485 connector inside the HGM-RD allows a Building Management System to “talk” to the HGM-MZ network through the HGM-RD. The connection is established using a shielded twisted pair cable.

Use any of the remaining service knockouts to gain access to the interior of the HGM-RD. Locate the RS-485 connector marked “TO HOST” (Page 12) and remove it from the circuit board. Secure the wire leads to the connector orienting them as shown in the diagram below. Check to make sure that the polarity matches the wiring to the Building Management System. When you are through securing the connections, carefully plug the connector back onto the circuit board.

#### RS-485 Connector

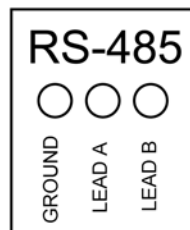

## Changing Terminator Switch Settings

The terminator switch for the RS-485 “TO MONITORS” connector is shipped from the factory in the terminated or “IN” position. This is the correct setting if the HGM-RD is connected to only one HGM-MZ, or if it is the last device on a network chain. If the HGM-RD is being installed in the middle of a network, the terminator must be moved to the “OUT” position. Refer to **Multiple HGMs** on Page 20.

The terminator switch for the RS-485 “TO HOST” connector is shipped from the factory in the terminated or “IN” position. This is the correct setting if the HGM-RD is the last device on the network chain. If other devices are daisy chained through the HGM-RD, the terminator must be moved to the “OUT” position. Refer to **Connecting to a Building Management System** on Page 20.

Locate each terminator switch and determine its position. If it needs to be moved, carefully slide the switch to the proper position.

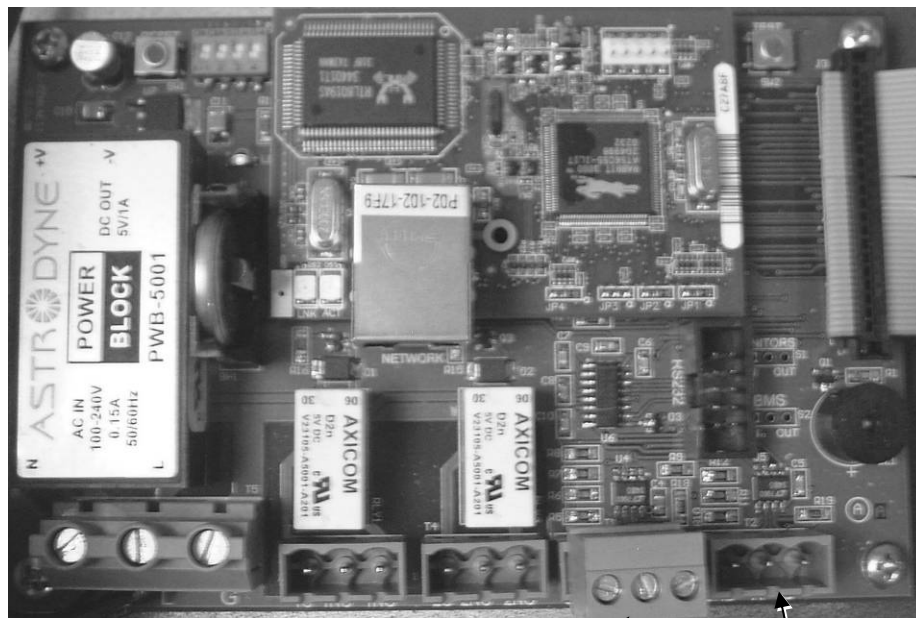

**RS-485  
TO MONITOR  
Connector**

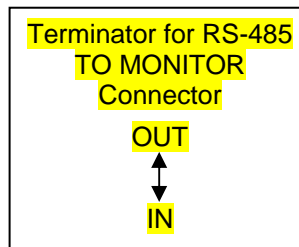

**RS-485  
TO HOST  
Connector**

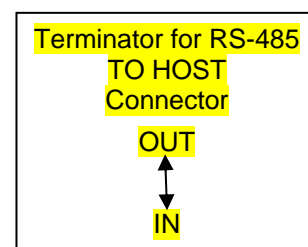

# Connecting External Alarms

## Overview

Two SPDT relays are available for the connection of external alarm devices. These alarms are useful for alerting the user to global conditions anywhere on the network. Each relay can be programmed to respond to alarm, fault, or ready conditions.

## Connection

Use the AC conduit or any of the remaining service knockouts to gain access to the interior of the HGM-RD. Locate the relay connector (Page 12) and remove it from the circuit board. Secure the wire leads to the connector orienting them as shown in the diagram below. When you are through securing the connections, carefully plug the connector back onto the circuit board.

**HGM-RD Relay Connector**

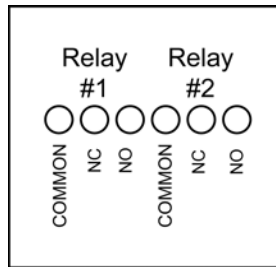

**NOTE:** Each relay can be connected as normally open (NO), or normally closed (NC).

Power for the external alarms can be tapped off the AC IN connector.

The relay contacts are rated .5 A at 250 VAC and 1.0A at 30 VAC.

*(This is in the MZ manual. Do you want it here too?)*

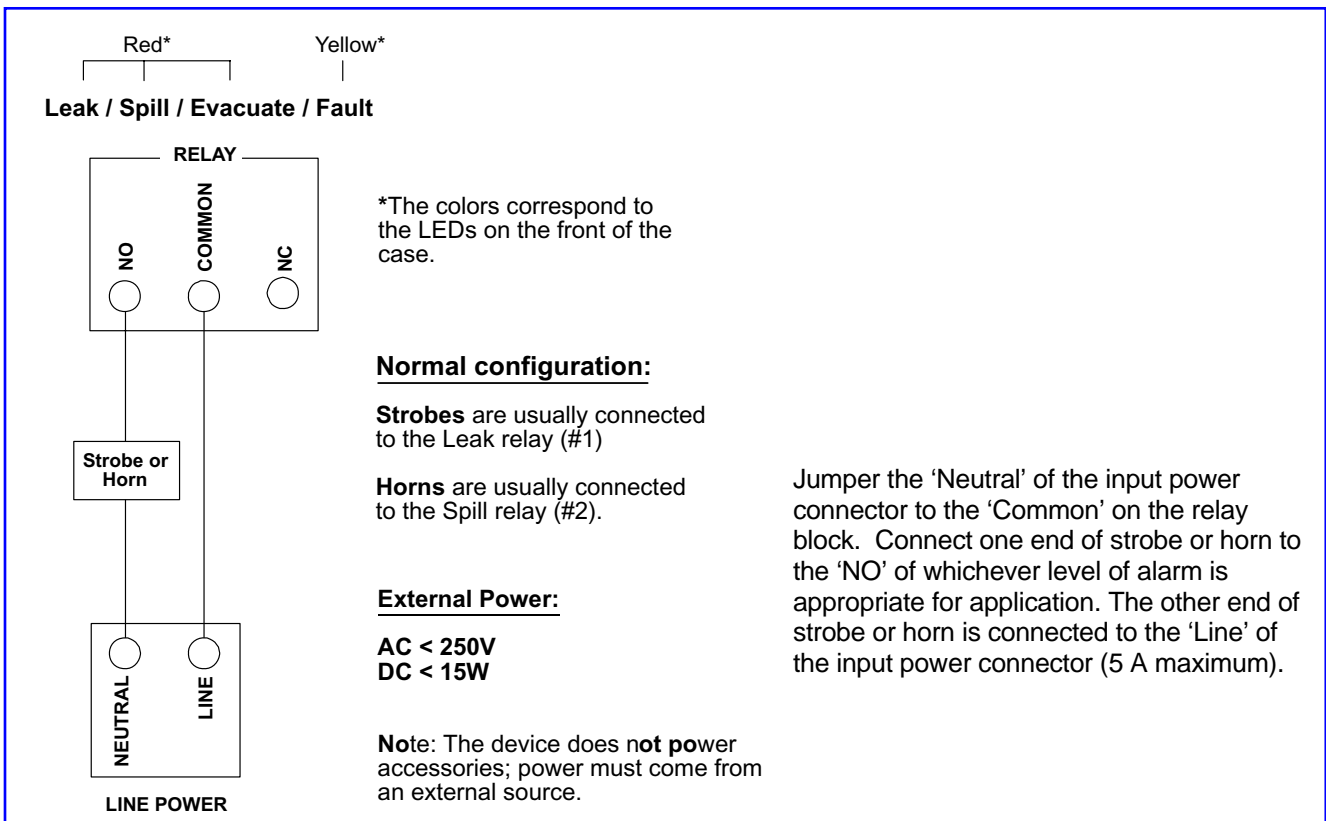

# 3 Operation

## HGM-Remote Display

The HGM-RD displays comprehensive information about the HGM-MZ network status and enables complete programming control of all system operations.

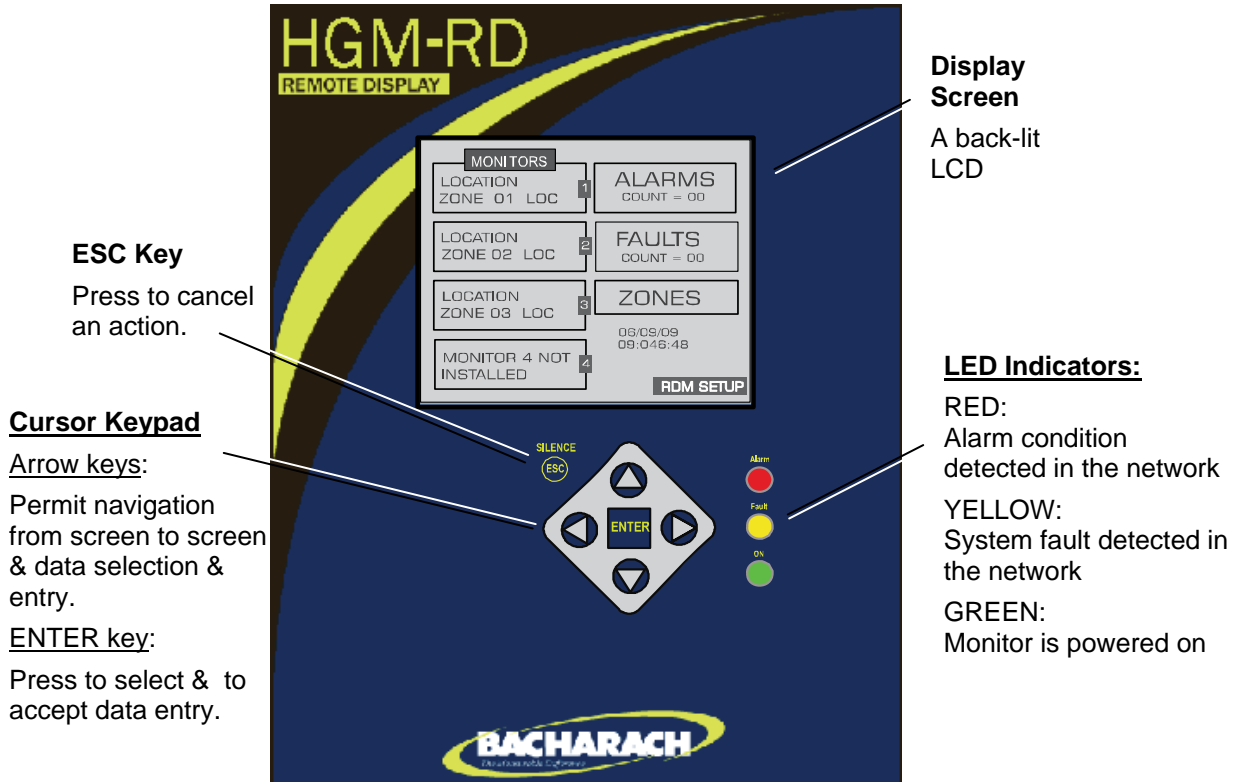

## Internal Audible Alarm

An internal audible alarm is provided which can be programmed to sound when there is an occurrence of the selected condition (refer to **Audible Alarm** on Page 22).

## External Alarms

Additionally, 2 SPDT relays are provided for the connection of external alarm devices. These alarms are useful for alerting the user to global conditions anywhere on the network. Each relay can be programmed to respond to alarm, fault, or ready conditions.

## Screen Displays

When first powered up, a splash screen appears indicating the firmware revision number. After a brief moment the System Screen is displayed.

There is a 15-minute warm-up period after power is first applied. Under "HGM" Monitors, "WARM UP" is displayed. The green indicator on the HGM will blink during the warm-up period. (*true?*)

**IMPORTANT:** DO NOT block the gas-sample hose or inlet port of any zone. The monitor will perform a vacuum test during start up and a blocked zone will give a false indication. (*?This was deleted from MZ manual.*)

### System Screen

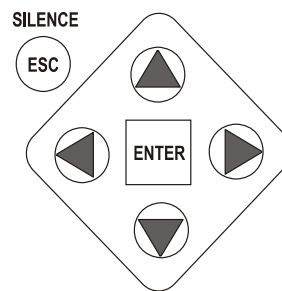
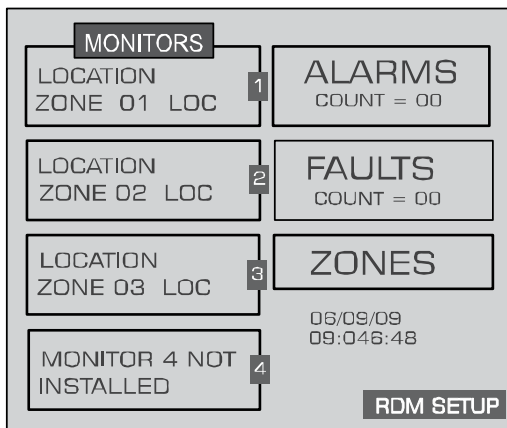

- Use the **Arrow** keys for multi-directional movement in making selections & moving the cursor.
- Use the **ENTER** key to initiate & complete a selection.
- Use the **ESC** key to go back (cancel) or to silence an alarm.

## System Programming

### Setup Parameters

Before working with the HGM-MZ network, several global parameters must be defined. Most of these are entered in the **RDM Setup Screens** or via the **PC software**. Parameters must also be defined for each HGM-MZ monitor connected to the network. These settings serve to identify each monitor and define how they operate. These are entered in the **HGM Setup Screens**. Finally, parameters must be defined for each individual monitoring zone. These are entered in the **Zone Setup Screens**.

### Password Protection

The HGM-RD can be password protected to prevent the unauthorized editing of setup parameters. When password protection is enabled, an operator may still navigate between screens to observe settings or monitor network status. The password can be alpha-numeric.

The unit is shipped with password protection OFF. Entering a password in the **RDM Setup Screen #1** enables password protection. After protection is enabled, the user will be prompted to enter the password when an attempt is made to edit a setup parameter.

After entering the password, a 30 minute time period will be allowed for entries, after which the user will again be prompted to re-enter the password.

**IMPORTANT:** Please make note of your password and save it.

# Setup Programming

## Setting the Clock

On the **System Screen**, use the UP/DOWN arrow keys to select date and time. Press the ENTER key to access the **Clock setup screen**.

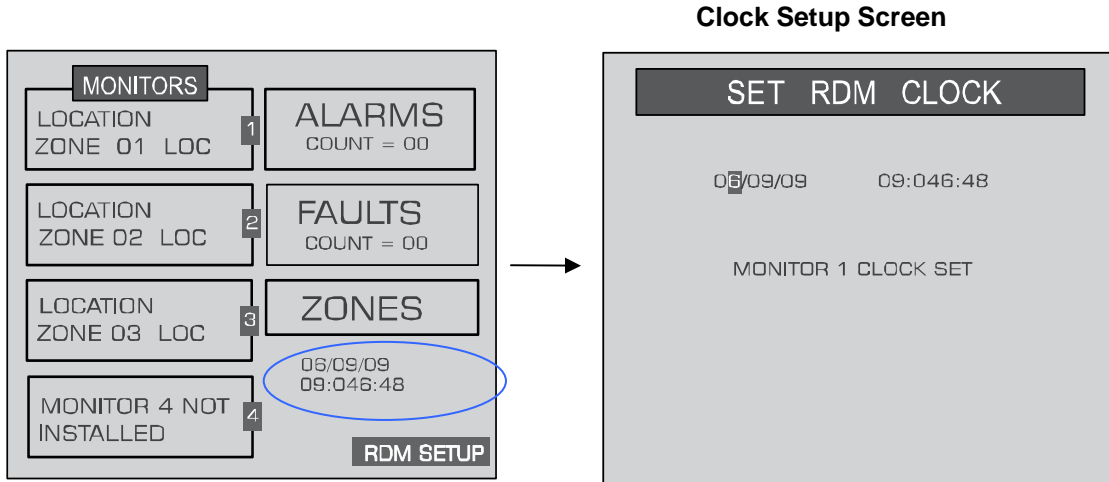

Use the LEFT/RIGHT cursor keys to move the cursor across the field to the value you wish to edit. Use the UP/DOWN cursor keys to modify the field value and press the ENTER key to accept your entries. When editing is complete, do one of the following:

- Select the SET HGM CLOCKS option to synchronize all HGM-MZ monitors to the current date/time setting.
- Select the ESC option to cancel all edits and revert to the previous setting.
- Press ENTER to accept the current date/time setting.

## Navigating to the 1<sup>st</sup> RDM Setup Screen

On the **System Screen**, select RDM SETUP. Press ENTER to access the **RDM Setup Screen #1**.

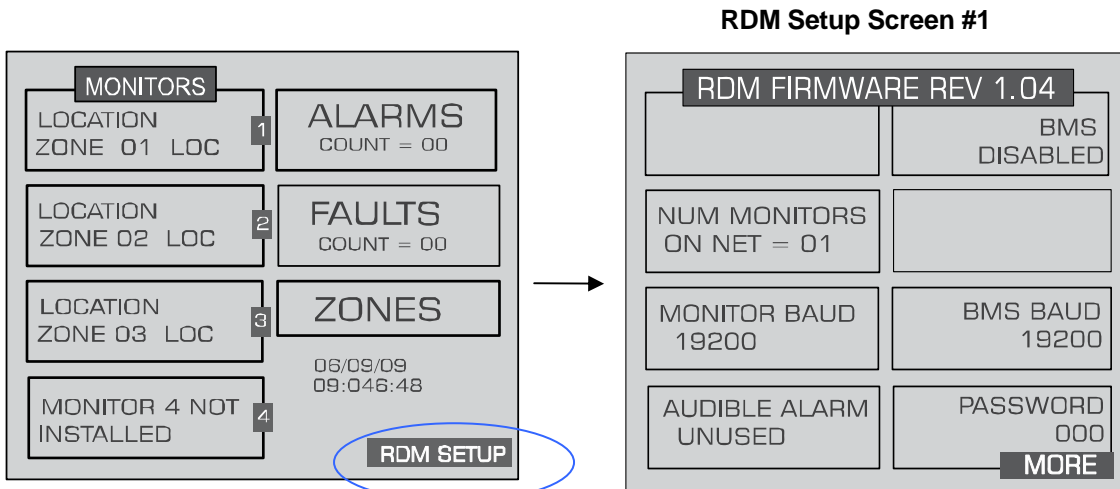

## Number of HGM Units

This is the number of HGM-MZ monitors connected to the HGM-RD.

1. Press the ENTER key to select. "NUM MONITORS" will flash.
2. Use the UP/DOWN cursor keys to modify the setting.
3. Press ENTER to accept the new entry or ESC to revert to the previous setting.

**NOTE:** When first powered up, the HGM-RD will automatically detect all HGM-MZ's on the network with unique node addresses. Refer to HGM Node Address on Page 22.

## HGM Baud Rate

This is the baud rate of all HGM-MZ monitors connected to the network.

1. Press the ENTER key to select.
2. Use the UP/DOWN cursor keys to scroll the setting.
3. Press ENTER to accept the new entry or ESC to revert to the previous setting.
4. The default value is 19200.

**NOTE:** All HGM-MZ's on the network must have the same baud rate.

## Audible Alarm

This parameter selects the function of the HGM-RD's internal audible alarm.

1. Press the ENTER key to select.
2. Use the UP/DOWN cursor keys to select Unused, Monitor on, Evacuate, Spill, Leak, Fault, or Alarm.
3. Press ENTER to accept the new entry or ESC to revert to the previous setting.

## Enabling Building Management System Connection

This enables or disables the connection to a Building Management System.

1. Press the ENTER key to select.
2. Use the UP/DOWN cursor keys to toggle the setting.
3. Press ENT to accept the new ENTERry or ESC to revert to the previous setting.

## Building Management System Baud Rate

This is the baud rate of the Building Management System.

1. Press the ENTER key to select.
2. Use the UP/DOWN cursor keys to scroll the setting.
3. Press ENTER to accept the new entry or ESC to revert to the previous setting.

## Password

This field is used to define a system password. The default setting is 000, which provides no password protection.

1. Press the ENTER key to adjust the password.
2. Use the LEFT/RIGHT cursor keys to move across the entry field and the UP/DOWN cursor keys to modify the individual characters.
3. Press ENTER to accept the new password or ESC to revert to the previous setting.

## Navigating to the 2<sup>nd</sup> RDM Setup Screen

On **RDM Setup Screen #1**, select **MORE** to access **RDM Setup Screen #2**. Select **BACK** to return to **RDM Setup Screen #1**.

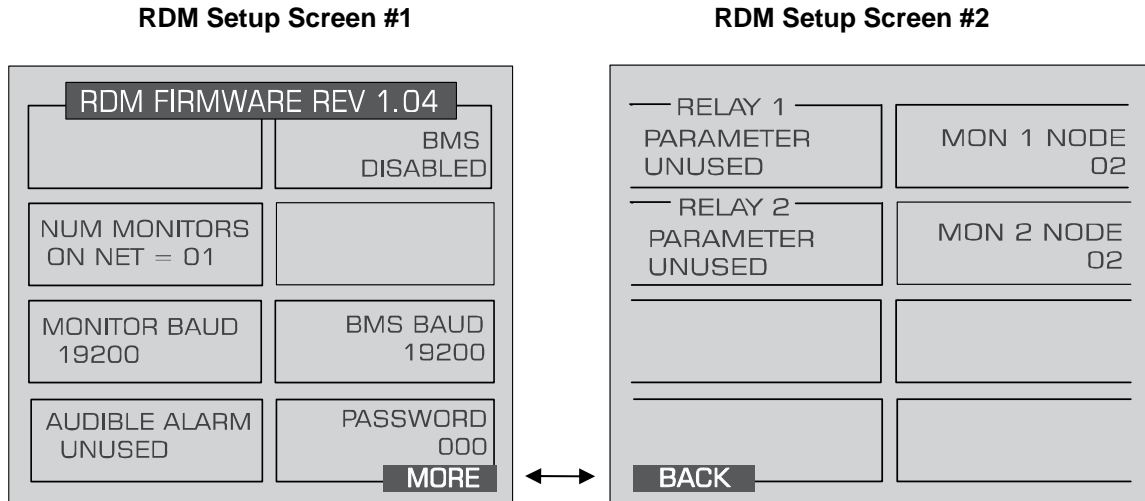

## Setting Relay Parameters

This setting determines the function of relays 1 and 2 mounted inside the RDM unit.

1. Press the ENTER key while the relay parameter you want to adjust is highlighted.
2. Use the UP/DOWN cursor keys to select Unused, Monitor On, Evacuate, Spill, Leak, Fault, or Alarm.
3. Press ENTER to accept the new entry or ESC to cancel.

## HGM Node Address

This value is the node address from 1 to 15 assigned to each HGM-MZ which is on the network. These values must match the settings on each HGM-MZ.

1. Press the ENTER key to adjust the address for each HGM-MZ.
2. Use the UP/DOWN cursor keys to modify the setting.
3. Press ENTER to accept the new entry or ESC to revert to the previous setting.

## Navigating to the 1<sup>st</sup> and then 2<sup>nd</sup> HGM Setup Screen

From the **System Screen**, select the HGM-MZ you wish to set up. Press the ENTER key to access that unit's **HGM Setup Screen #1**.

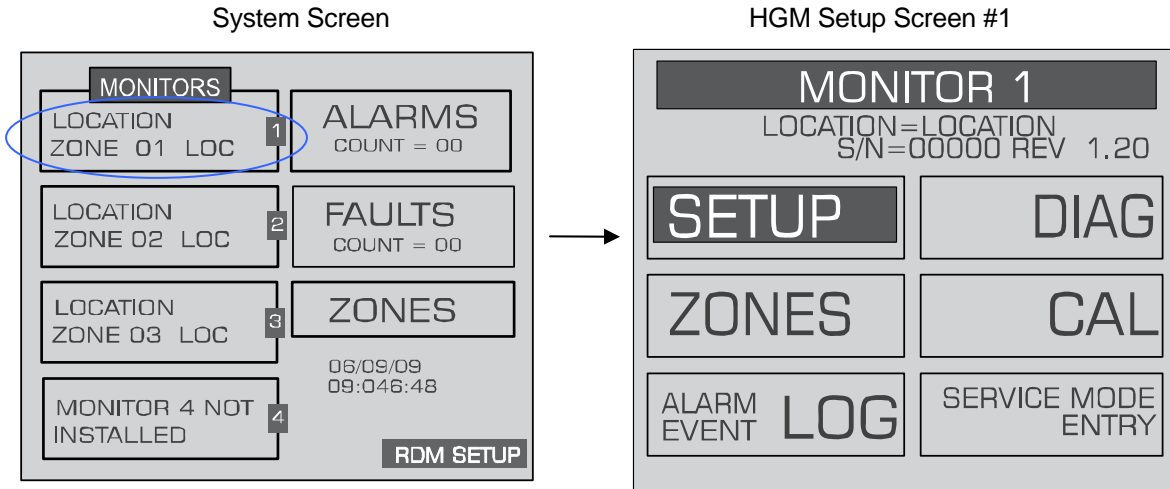

On **HGM Setup Screen #1**, select the **SETUP** option to go to **HGM Setup Screen #2**. To return to the **System Screen**, press **ESC**.

### HGM Setup Screen #2

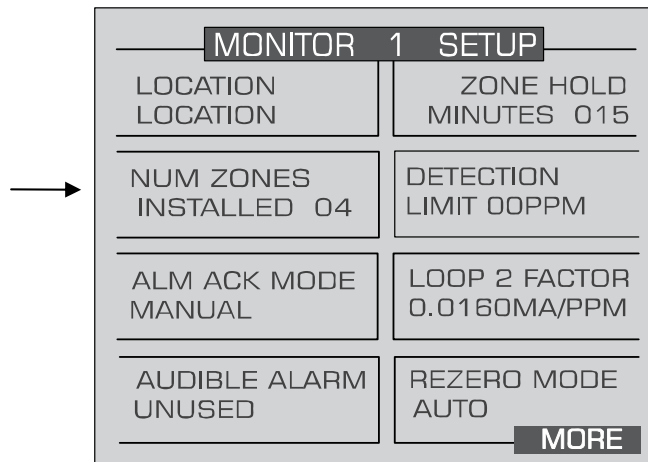

### Location

This is the name you assign to the HGM-MZ to identify its location. It may have up to 12 alphanumeric characters.

1. Press the ENTER key to adjust the setting.
2. Use the LEFT/RIGHT cursor keys to move across the entry field and the UP/DOWN cursor keys to modify the individual characters.
3. Press ENTER to accept the new entry or ESC to revert to the previous setting.

### Number of Zones Installed

**IMPORTANT:** Do not change the number of zones to deactivate excess zones. Instead, go to the individual zone that you wish to disable and set its distance to zero (refer to *Navigating to the 1st Zone Setup Screen* on

Page 27). The monitor will perform a self-check on power-up, and if the number of zones detected does not agree with the number of zones installed a fault will occur.

1. Press the ENTER key to modify the number.
2. Use the UP/DOWN cursor keys to modify the number.
3. Press ENTER to accept the new number or ESC to revert to the previous setting.

**NOTE:** The HGM-MZ auto setting detects the number of zones present on power-up. **DO NOT BLOCK ANY ZONES. A BLOCKED ZONE WILL GIVE THE MONITOR A FALSE INDICATION ON POWER-UP.** The number detected on power-up is the default value for this parameter.

### Alarm Ack Mode

This function programs the relays in the HGM unit for latching or non-latching operation.

1. Press the ENTER key to adjust the setting.
2. Use the UP/DOWN cursor keys to toggle between settings.
  - AUTO – Non-latching (Alarm relay will automatically de-energize when the gas level drops below its alarm point.)
  - MANUAL – Latching (Alarm relay remains energized, and will not release until the alarm condition has been manually acknowledged. Refer to *Acknowledging Alarms* on Page 37.)
3. Press ENTER to accept the new entry or ESC to revert to the previous setting.

### Audible Alarm

This parameter selects the function of the HGM-MZ's internal audible alarm device.

1. Press the ENTER key to modify the setting.
2. Use the UP/DOWN cursor keys to select unused, monitor on, evacuate, spill, leak, fault, or alarm.
3. Press ENTER to accept the new entry or ESC to revert to the previous setting.

### Zone Hold Time

Sets the length of time a zone will be monitored when the zone hold feature is actuated (refer to **Zone Hold Mode** on Page 29). The default is 15 minutes. This parameter can be set to any value between 1 and 999 minutes.

1. Press the ENTER key to modify this setting.
2. Use the LEFT/RIGHT cursor keys to move across the entry field and the UP/DOWN cursor keys to modify the individual numbers.
3. Press ENTER to accept the new entry or ESC to revert to the previous setting.

### Detection Limit

This is essentially a squelch setting that instructs the instrument to interpret PPM readings below the designated level as 0. You can set this value from 1 to 99 PPM.

1. Press the ENTER key to modify the setting.
2. Use the UP/DOWN cursor keys to modify the setting.
3. Press ENTER to accept the new entry or ESC to revert to the previous setting.

### Loop2 Factor

This sets the PPM scale factor for current loop number 2. To calculate the current output, multiply the scale factor by the PPM and add 4. For example, at the default scale factor of 0.016, a measurement of 100ppm would generate a current output of 5.6 mAdc. The current output cannot exceed the 20 mAdc capacity of the interface.

1. Press the ENTER key to modify the setting.
2. Use the LEFT/RIGHT cursor keys to move across the entry field and the UP/DOWN cursor keys to modify the individual characters.
3. Press ENTER to accept the new entry or ESC to revert to the previous setting.

## Re-Zero Mode

This parameter defines the frequency at which the instrument re-zeros the optical sensor.

1. Press the ENTER key to modify the setting.
2. Use the UP/DOWN cursor keys to toggle between settings.
  - AUTO – Sets the instrument to re-zero every 10 minutes.
  - ZONE CHANGE – Sets the instrument to re-zero at each zone change. This is the most accurate setting but increases the time interval between measurement cycles.
3. Press ENTER to accept the new entry or ESC to revert to the previous setting.

## Navigating to the 3<sup>rd</sup> HGM Setup Screen

From **HGM Setup Screen #2**, select the MORE option to go to **HGM Setup Screen #3**. Select the BACK option to return to **HGM Setup Screen #2**. To return to the **System Screen**, press **ESC**.

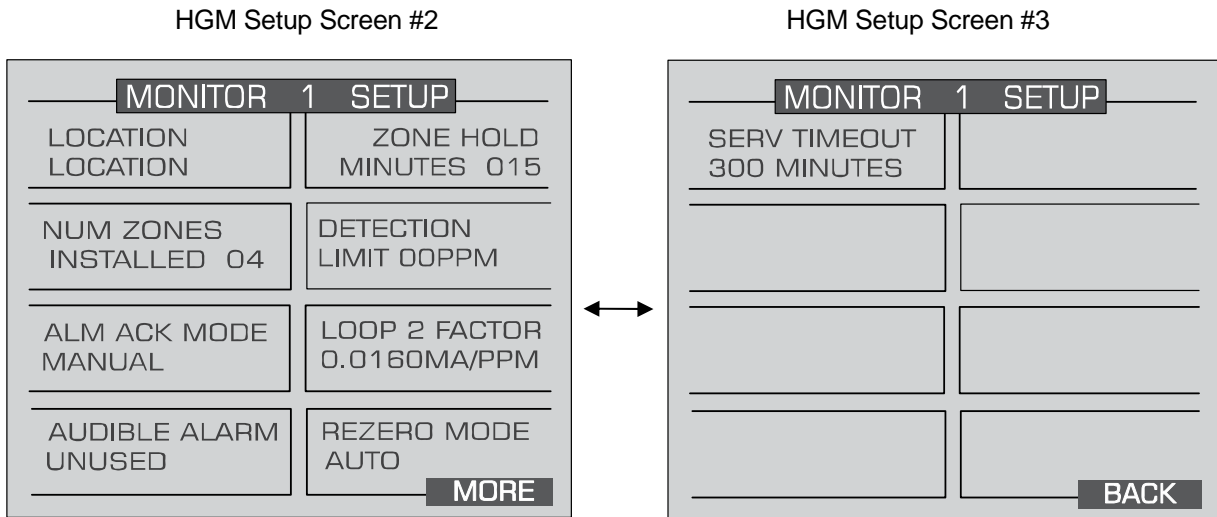

## Service Timeout

Sets the length of time the Service Mode is in effect. Stops the monitor for up to 240 minutes (4 hrs) to allow for servicing the unit. Refer to *Service Mode* on Page 46.

1. Press the ENTER key to modify the setting.
2. Use the LEFT/RIGHT cursor keys to move across the entry field and the UP/DOWN cursor keys to modify the individual numbers.
3. Press ENTER to accept the new entry or ESC to revert to the previous setting.

# Zone Setup Programming

## Navigating to the 1<sup>st</sup> Zone Setup Screen

On the **System Screen**, select the monitor in the zone you wish to modify and press ENTER. The Monitor screen for the selected zone will be displayed. On this screen, select ZONES.

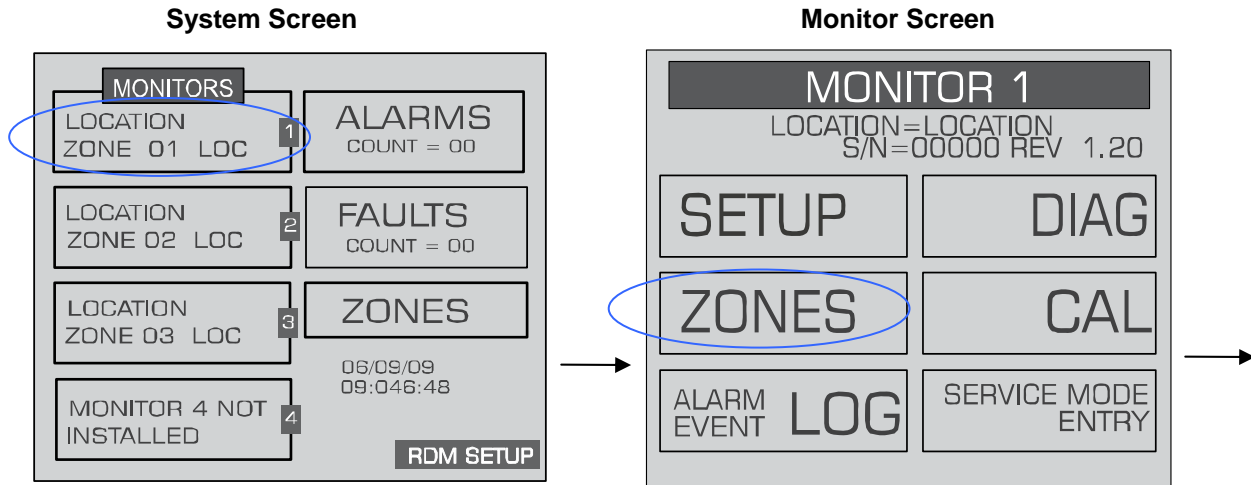

The Zone Setup screen will be displayed. To return to the **System Screen**, press **ESC**.

### Zone Setup Screen #1

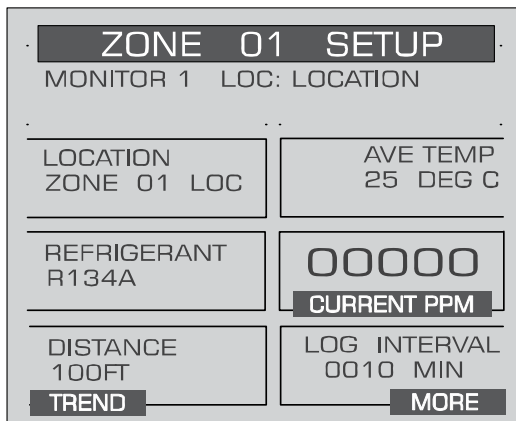

### Location

This is the name you assign to the monitoring zone. It may have up to 12 alphanumeric characters.

1. Press the ENTER key to select then first letter in the name.
2. Use the LEFT/RIGHT cursor keys to move across the entry field and the UP/DOWN cursor keys to modify the individual characters.
3. Press ENTER to accept the new entry or ESC to revert to the previous setting.

## Refrigerant

This is the type of refrigerant gas being monitored.

1. Press the ENTER key to adjust the setting.
2. Use the UP/DOWN cursor keys to scroll through the list of gas types.
3. Press ENTER to accept the entry or ESC to revert to the previous setting.

## Distance

This is the tubing length in feet from the HGM-MZ to the termination of the air intake line. This value may range from 0 to 500 feet. The default value is 100 feet. Setting this value to “0” causes the zone to be bypassed during normal operation, and the word “DISABLED” to appear in place of the zone’s PPM reading in the **Zone Screen**.

1. Press the ENTER key to modify the number.
2. Use the UP/DOWN cursor keys to modify the setting.
3. Press ENTER to accept the new entry or ESC to revert to the previous setting.

## Average Temperature

This temperature reading may be changed to the exact temperature at the sample point for greater accuracy. The adjustment range is from –50 to +70 degrees C.

1. Press the ENTER key to adjust the temperature value.
2. Use the LEFT/RIGHT cursor keys to move across the entry field and the UP/DOWN cursor keys to modify the setting.
3. Press ENTER to accept the new entry or ESC to revert to the previous setting.

## Current PPM

This box displays the last PPM measurement recorded in this zone. You can not modify this value.

## Log Interval

Sets the length of time between entries in the trend log. The default is one entry every 1440 minutes (24 hrs). A value of 000 indicates that each measurement for a given zone is logged into the trend log.

1. Press the ENTER key to adjust the log interval value.
2. Use the LEFT/RIGHT cursor keys to move across the entry field and the UP/DOWN cursor keys to modify the setting.
3. Press ENTER to accept the new entry or ESC to revert to the previous setting.

*[Trend here, or in following section, or both?](#)*

## Navigating to the 2<sup>nd</sup> Zone Setup Screen

On **Zone Setup Screen #1**, select **MORE** to access **Zone Setup Screen #2**. Select **BACK** to return to **Zone Setup Screen #1**. To return to the **System Screen**, press **ESC**.

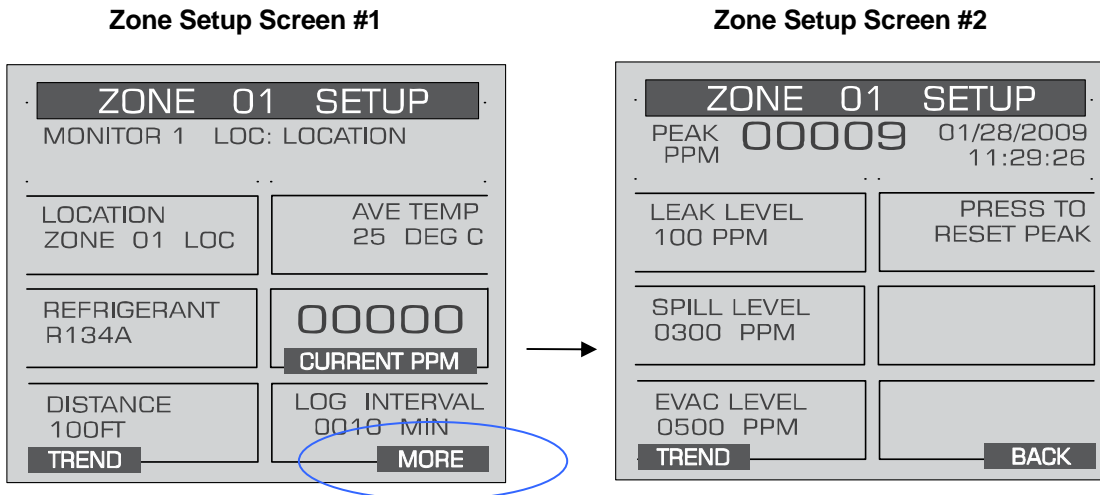

### Leak Level

This is the concentration level in PPM that will activate a leak alarm condition.

1. Press the ENTER key to adjust the value.
2. Use the UP/DOWN cursor keys to modify the setting.
3. Press ENTER to accept the new entry or ESC to revert to the previous setting.

**NOTE:** This value must be less than the spill level.

### Spill Level

This is the concentration level in PPM that will activate a spill alarm condition.

1. Press the ENTER key to adjust the value.
2. Use the UP/DOWN cursor keys to modify the setting.
3. Press ENTER to accept the new entry or ESC to revert to the previous setting.

**NOTE:** This value must be less than the evacuate level and greater than the leak level.

### Evacuation Level

This is the concentration level in PPM that will activate an evacuate alarm condition.

1. Press the ENTER key to adjust the value.
2. Use the UP/DOWN cursor keys to modify the setting.
3. Press ENTER to accept the new entry or ESC to revert to the previous setting.

**NOTE:** This value must be greater than the spill level.

### Re-Setting the Peak PPM Value

Pressing this key resets the current peak PPM level stored in memory and displays it at the top of the screen.

**Navigating to the Trend Screen (No Trend text in this doc. Following text was taken from the MZ manual.)**

On **Zone Setup Screen #2**, select the **Trend** option on the bottom left side to access the **Trend** screen.

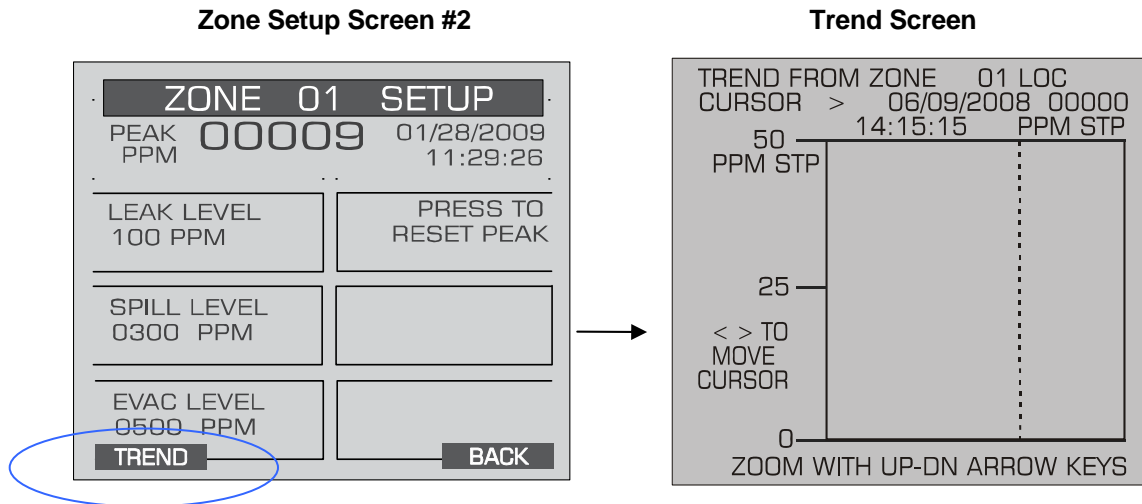

The trend graph opens with the cursor located over the most recent data point. Use the LEFT/RIGHT cursor keys to move the cursor to different data points. Holding a key down will cause the cursor to move rapidly across the screen. As you move the cursor position, the date and time of that reading, along with the PPM value, are displayed at the top of the screen above the graph. The trend graph is automatically scaled to accommodate the largest PPM value displayed. The ZOOM OUT and ZOOM IN options allow you to adjust the vertical scale of the graph.

The trend data is stored on a first-in, first-out basis. After 100 trend values have been stored the 101<sup>st</sup> value will replace the first value stored. Therefore, in normal operation, when entering trend mode the cursor will be located at the most recent data point. The data points to the left of the initial cursor location will be the next most recent. The data point to the right will be the oldest data point in the buffer and will be over written by the next data point.

The Trend Data Log can be reset by pressing a combination of the ENTER and RIGHT arrow buttons while viewing the log.

When finished, press the ESC key to revert to the previous screen. *(or system screen?)*

# 4 General Operation

## Functional Overview

Normally each HGM-MZ will sequentially perform measurements on its active zones without user input. The total time it takes an HGM-MZ to complete a measurement cycle is directly proportional to the number of active zones and the physical length of the air lines. Monitors linked together on a network operate independently of each other and consequently complete their respective measurement cycles at different rates.

The HGM-RD operates by polling the network approximately once every 12 seconds to determine the current status of the HGM-MZ monitors. If more than one HGM-MZ is connected to the network, it will sequentially poll each monitor for its status. This means that the more complicated the network, the longer it will take the HGM-RD to update the status information for all zones.

To display all the zones being monitored, go to the **System Screen** (Page 19) and press the ZONES key.

## The Zone Screen

The top level **Zone Screen** provides a summary view of zone activity across the network. Each screen displays information from a single HGM-MZ monitor as indicated at the top of the display. Each screen can display information for up to 8 zones, and depending on the configuration of the system, there can be up to two screens for each HGM-MZ. Use the UP/DOWN cursor keys or the NEXT key to scroll the screen display.

Each box displays the zone location and the last PPM measurement. A blinking box indicates that a measurement is currently being taken in that location. An inverse flashing box indicates an alarm condition in that zone.

Use the LEFT/RIGHT cursor keys to scroll through the zones.

### Zone Screen

MONITOR 1 LOCATION	
ZONE 01 LOC 0 PPM	
ZONE 02 LOC 0 PPM	
ZONE 03 LOC 0 PPM	
ZONE 04 LOC 0 PPM	
ALARMS	

To further investigate the status of any zone, select the zone and press the ENTER key. That monitor's **Zone Setup Screen #1** will be displayed.

## Alarm Conditions

When an alarm condition is detected anywhere on the network the red ALARM LED will glow. Additionally, an external alarm device may activate and an audible alarm may sound if those features have been enabled (Pages 21 & 25).

An inverse flashing box indicates an alarm condition in the affected zone.

### Zone Screen (Alarm Mode)

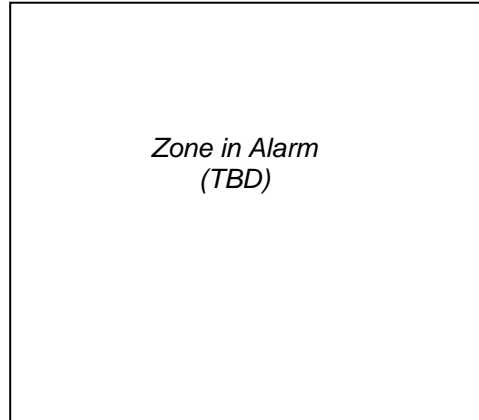

If the current **Zone Screen** appears normal, scroll through the displays using the NEXT/BACK keys or the UP/DOWN cursor keys until you locate the affected zone. To further investigate the status of an affected zone, select the zone and press the ENTER key. That **Zone's Setup Screen #1** will be displayed. You may also select ALARMS to access the **Alarm Summary Screen** (Page 34). Refer to *Working with Alarms* on Page 34 to learn more about responding to alarms.

## Fault Conditions

If a system malfunction occurs, the yellow FAULT LED will glow. Additionally, an external alarm device may activate and an audible alarm may sound if those features have been enabled (Pages 21 & 25).

From the top level **Zone Screen** (Page 30), make sure no zones are selected and press ENTER to go to the **System Screen** (Page 19) and then press the FAULTS key to go to the **Fault Screen** (Page 38). Refer to *System Faults* on Page 39 to learn more about responding to system faults.

### Fault Screen

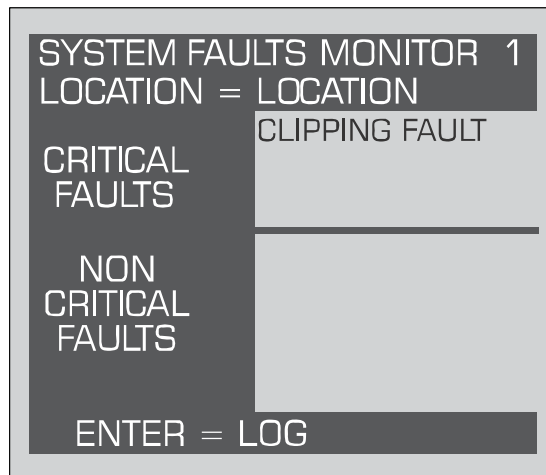

## The System Screen

The **System Screen** provides a summary view of the entire HGM-MZ network. The boxes on the left side of the screen indicate the status of each HGM-MZ monitor. This includes the name, the current zone, and if fault or alarm conditions are present on the network.

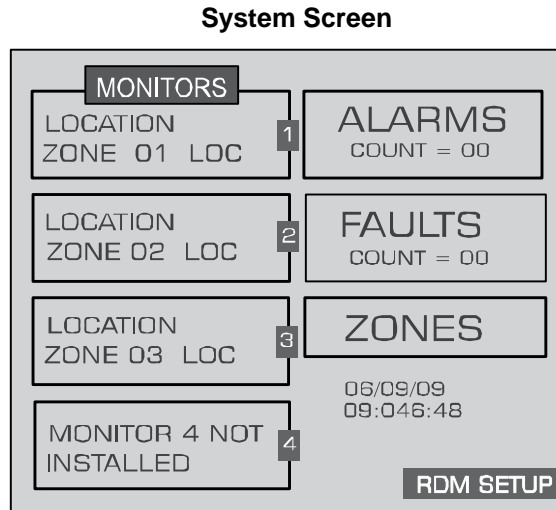

## Alarm Conditions

When an alarm condition is detected anywhere on the network the red ALARM LED will glow. Additionally, an external alarm device may activate and an audible alarm may sound if those features have been enabled (Pages 21 & 25).

The ALARMS box in the upper right hand corner of the screen will blink and the count value will change to indicate the total number of alarm conditions on the network. To investigate an alarm, select the ALARMS option to go to the Alarm Summary Screen (Page 34). Refer to *Alarms* on Page 34 to learn more about responding to alarms.

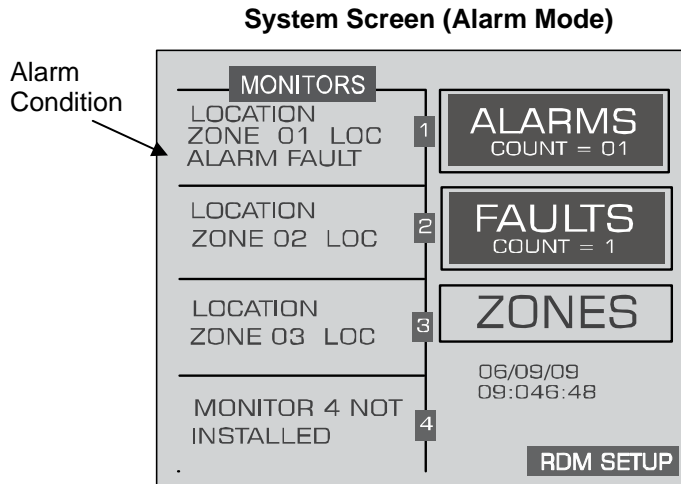

## Alarm Log

On the **System Screen**, select the HGM-MZ unit you wish to view and press ENTER.

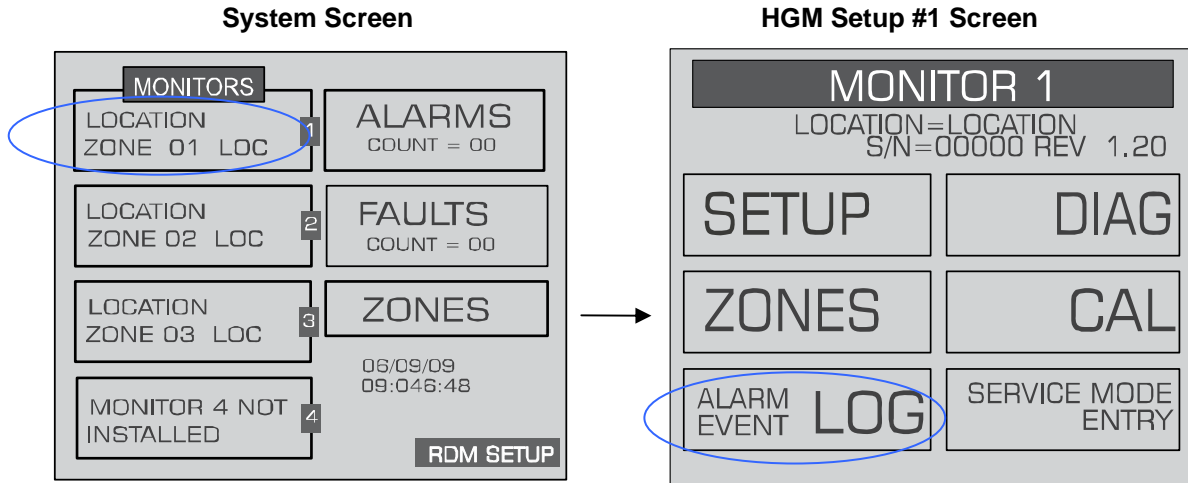

Select the ALARM EVENT LOG option and press ENTER to display the **Alarm Log Screen**.

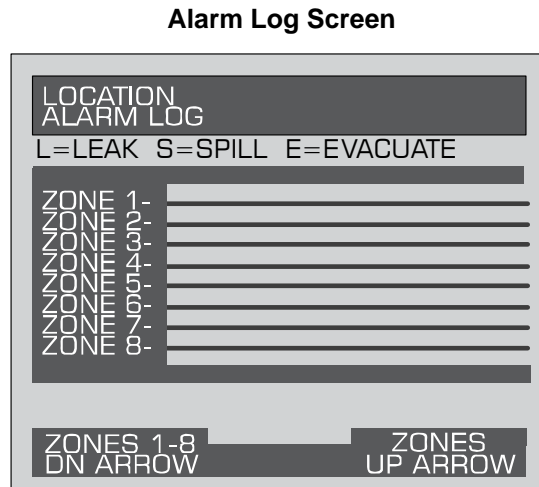

Use the LEFT/RIGHT and UP/DOWN cursor keys to move through the log.

The Alarm log shows the last **20 alarm** events. An alarm event is the occurrence of any alarm, any change in alarm level, or the clearing of any alarm. The alarm level is indicated by an L (leak), S (spill), or E (evacuate). The time and date of the alarm are displayed when the cursor is placed over the alarm.

### Fault Conditions

If a system malfunction occurs, the yellow FAULT LED will glow. Additionally, an external alarm device may activate and an audible alarm may sound if those features have been enabled (Pages 21 & 25).

The FAULTS box on the right of the screen will blink and then counts the number of HGM units on the system with a fault. To investigate a fault, select the FAULTS option to go to the **Fault Screen** (Page 31). Refer to *Working with System Faults* on Page 39 to learn more about responding to system faults.

#### System Screen (Fault Mode)

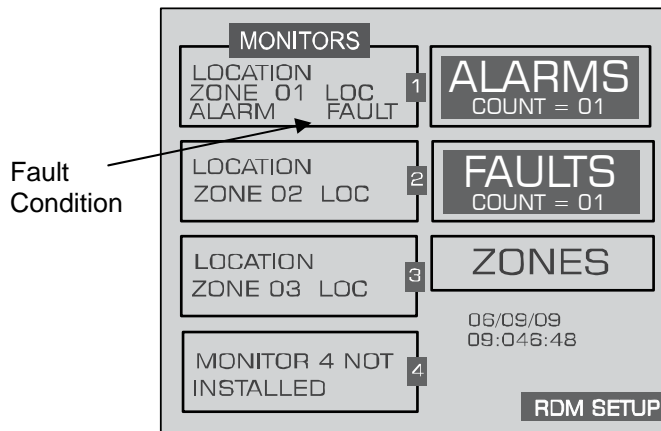

# Alarms

## Functional Overview

If the PPM level for any zone exceed its designated spill, leak, or evacuate thresholds, an alarm condition will be created. Once the HGM-MZ completes a measurement cycle in the affected zone the alarm condition will be indicated. At that time the red ALARM LED on the HGM-MZ will glow. Additionally, an external alarm device may activate and an audible alarm may sound if those features have been enabled (Pages 21 & 25).

The next time the HGM-RD polls the affected monitor its red ALARM LED will glow. Additionally, an external alarm device may activate and an audible alarm may sound if those features have been enabled (Pages 21 & 25).

The alarm condition may or may not have to be acknowledged for the system to return to normal operation.

## Responding to Alarms

There are two screens from which an operator can respond to alarms:

- From the **System Screen** (Page 18) select the ALARMS field to go to the **Alarm Summary Screen**.
- From the top level **Zone Screen** (Page 30) select the ALARMS field at the bottom of the display screen to go to the **Alarm Summary Screen**.

### Alarm Summary Screen

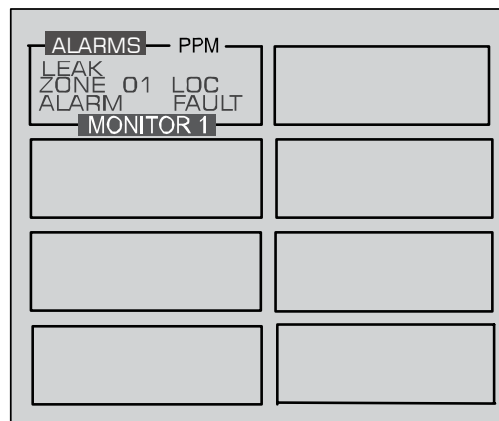

The **Alarm Summary Screen** displays a list of all alarm conditions pending across the network. The screen is divided into 8 boxes, and each box represents a single alarm. If more than 8 alarms are pending additional pages can be displayed by pressing the MORE key.

Each box displays the zone number, zone name, and the current PPM reading. A flashing box indicates an alarm that has not been acknowledged. A static box represents an alarm that has been acknowledged but has not yet been cleared from the system.

## Alarm Detail Screen

To further investigate an alarm, select the alarm on the Alarm Summary screen, then press ENTER to access the **Alarm Detail Screen**.

### Alarm Detail Screen

ALARM SUMMARY	
ZONE	02 LOC
MONITOR 1 ZONE 02 LOCATION	
00000	R402A
PPM NOW	REFRIGERANT
00142	06/12/08 10:13:13
PPM PEAK ALARM	PEAK TIME ALARM TIME
LEAK	06/12/08 10:13:13
<<= ACK	>>= SETUP

The **Alarm Detail Screen** displays more comprehensive information about the nature of the alarm including:

- Complete location information
- Refrigerant and current PPM
- Peak PPM and peak time
- Type of alarm, alarm time, and date

This screen provides the following three options at the bottom of the display:

- ACK (<<)** Acknowledges the alarm as described in the next section
- ESC** Returns you to the **Alarm Summary Screen**
- SETUP (>>)** Takes you to **Zone Setup Screen #1** (Page 27), which enables you to review the zone setup parameters and access the **Trend Screen**

## Acknowledging Alarms

Each pending alarm may require, depending upon selected alarm mode, acknowledgment before the system returns to normal operation (refer to *Alarm Ack Mode* on Page 25). To acknowledge an alarm, navigate to the **Alarm Detail Screen** and press the ACK key as previously described. You will then be returned to the **Alarm Summary Screen** and the box associated with that alarm will no longer be blinking, indicating that the alarm has been acknowledged. Repeat this procedure to acknowledge any remaining alarms.

### Alarm Summary Screen (Acknowledge Mode)

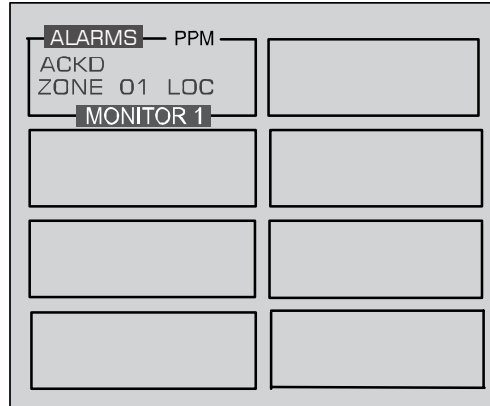

When all the alarms associated with a given HGM-MZ are acknowledged, its RED LED will turn off and any external alarms connected to the HGM-MZ relays will de-activate. All pending alarms across the entire network must be acknowledged before the HGM-RD returns to normal operation. When that occurs, its RED LED will turn off and any associated external alarms connected to the HGM-RD relays will de-activate.

The system will continue to generate new alarms if PPM values above the alarm thresholds are detected.

## The Trend Screen

### Overview - Log Interval

The HGM-MZ retains a data log of 100 measurements for each zone. The log interval is the number of minutes from 1 to 1440 between each log point. This parameter can be changed from **Zone Setup Screen #1** (Page 27).

The default setting for this parameter is 1440 minutes (24 hours). If the log interval time is set to 0, then a measurement is recorded in the trend log after *every measurement cycle*. Therefore, after the trend log is filled it will contain the last 100 measurement points for a zone. If you want the data logged less frequently you should increase this value. It is important to remember that cycle time is dependent on many factors, including the number of zones being monitored, input line length, and the run zeroing mode selected. Before changing this value it may be useful to first review the log data using the **Trend Screen** to determine the nominal cycle time.

### Navigating to the Trend Screen

Access the **Trend Screen** from the **Zone Screen** as follows:

From the top level **Zone Screen** (Page 30) press the key adjacent to the zone you wish to work with to first display its **Zone Setup Screen #1**. Then press the TREND key at the bottom of the display to go to the **Trend Screen**.

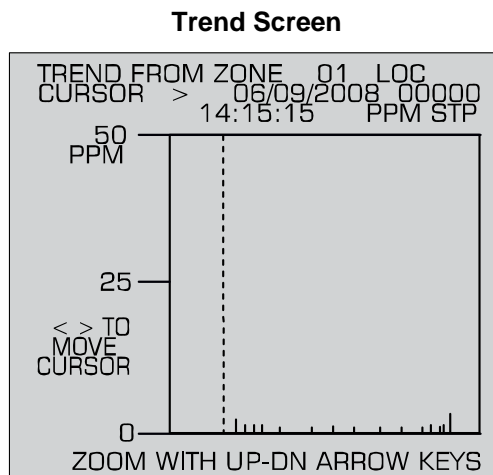

The trend graph opens with the cursor located over the most recent data point. Use the LEFT/RIGHT cursor keys to move the cursor to different data points. Holding a key down will cause cursor to move rapidly across the screen. As you move the cursor position, the date and time of that reading, along with the PPM value, are displayed at the top of the screen above the graph. The trend graph is automatically scaled to accommodate the largest PPM value displayed. The ZOOM OUT and ZOOM IN options, located in the bottom corners of the screen, allow you to adjust the vertical scale of the graph.

The trend data is stored on a first-in, first-out basis. After 100 trend values have been stored the 101<sup>st</sup> value will replace the first value stored. Therefore, in normal operation, when entering trend mode the cursor will be located at the most recent data point. The data points to the left of the initial cursor location will be the next most recent. The data point to the right will be the oldest data point in the buffer and will be over written by the next data point.

# System Faults

## Functional Overview

If a system malfunction occurs, the HGM-MZ will detect the problem and cause its yellow FAULT LED to glow. Additionally, an external alarm device may activate and an audible alarm may sound if those features have been enabled (Pages 21 & 25).

The next time the HGM-RD polls the affected monitor its yellow FAULT LED will also glow. Additionally, an external alarm device may activate and an audible alarm may sound if those features have been enabled (Pages 16 & 25).

Depending on the nature of the fault, the HGM-MZ may or may not continue to operate normally. Under a non-critical fault condition, the HGM-MZ will continue to measure and log data, but some peripheral functions may be compromised. Under a critical fault condition, action is required for the HGM-MZ to operate normally. The table on the following page lists the various fault conditions and explains what action should be taken to correct the problem.

## Navigating to the Fault Screen

Display the **System Screen** (Page 19); and then press the FAULTS key to display the **Fault Screen** of the selected monitor.

**Fault Screen**

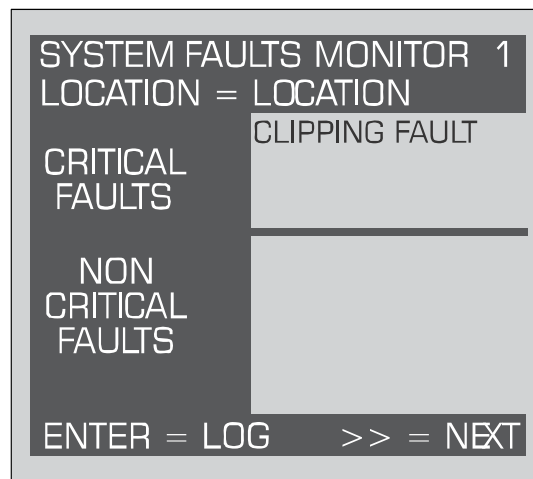

## CRITICAL FAULTS

- **NO FLOW ON ZONE** – Go to the **System Screen** (Page 19) and press the ZONES key. The **Zone Screen** will display a “NO FLOW” message in each individual zone affected. Check for a blockage in the air sample line or at the line end filter. Once the blockage has been cleared, the HGM-MZ will return to normal operation after the zone has been sampled. **NOTE:** *This may take several minutes since it is dependent upon how many zones there are and their lengths.* The HGM-MZ will clear the fault the next time it polls the effected zone and the HGM-RD will return to normal operation the next time that it polls the HGM-MZ.
- **NO FLOW ON PURGE** – Check the purge line for a blockage. Verify that the length of the purge line and exhaust line do not exceed 300 feet in length.
- **NO FLOW DETECTED** – Check for proper pump operation. Check the water trap – drain if necessary.
- **CLIPPING FAULT** – The detector voltage may be out of tolerance. Check the **Diagnostic Screen** for the DET voltage, AVE voltage and ZERO voltage. Call the factory with this information for further instructions.

- **REZERO VOLT TOL** – The detector output voltage is out of tolerance. Check the **Diagnostic Screen** as in item 4 and contact the factory for assistance.
- **TRIGGER FAULT** – No trigger from IR source pulser. Contact factory with all information from the DIAGNOSTIC SCREEN for farther instructions.

## NON CRITICAL FAULTS

- **BOX TEMP FAULT** – Enclosure's internal temperature is outside normal range (or IR sensor has failed). Check the installation to verify that the monitor is not being subjected to extreme temperatures. Verify that the ventilation holes are not obstructed. Check the **Diagnostic Screen** for the ZERO temperature, BNCH temperature and BOX temperature. Call the factory with this information for further instructions.
- **BENCH TEMP FAULT** – Optical bench is outside of normal operating range (or sensor has failed). Check the installation to verify that the monitor is not being subjected to extreme temperatures. Check the **Diagnostic Screen** for the ZERO temperature, BNCH temperature and BOX temperature. Call the factory with this information for further instructions.
- **PRESSURE SENSOR** – Manifold pressure is outside normal operating range (or sensor has failed). Check the **Diagnostic Screen** record ALL data. Call the factory with this information for further instructions.
- **LOOP FAULT** – This would only be displayed if the dual 4-20 mAdc option was installed and one or both current loops are open. Check the wiring to load/monitoring circuit on both 4-20 mA loops.
- **CONFIG FAULT** – There is an error in **HGM Setup Screen #2** – Number Zones Installed field, or in **RDM Setup Screen #1** – Number of HGMS on Network field. Check that the number of zones installed for each HGM unit and the number of HGM units on the network are properly programmed. Check to ensure that the manifold solenoid cable connector in each HGM unit is securely fastened to its terminal connector. Check for an illegal parameter. If necessary, reset to the factory default settings.

## Reset to Factory Default Settings

**IMPORTANT:** Performing this function deletes all program parameters, alarms, faults, trends and log files.

### Resetting the HGM-MZ –

1. Press and hold down the Factory Default switch inside the HGM-MZ (see **page**\_\_\_\_)
2. Cycle AC power OFF, then ON
3. After the unit emits five beeps, release the switch.
4. Reprogram the HGM-MZ as described in the *HGM-MZ – Setup Programming* section of the HGM-MZ Instruction Manual (P/N 3015-5074).

**Resetting the HGM-RD** – Occasionally it will be necessary to rest the HGM-RD to its factory default settings.

1. Press and hold down the Factory Default switch inside the HGM-MZ (see **page**\_\_\_\_)
2. Cycle AC power OFF, then ON;
3. After the unit emits five beeps, release the switch.

### Clearing System Faults

If the fault condition is associated with an HGM-MZ, the monitor will return to normal operation soon after the problem is corrected. At that time the YELLOW LED will turn off and any external alarms connected to the monitor's alarm relays will also turn off. The HGM-RD will return to normal operation the next time it polls the affected HGM-MZ monitor.

Once the system malfunction has been corrected it may take some time for the fault condition to clear completely. If the fault is associated with a specific zone, the HGM-MZ must first cycle back to the affected zone before it returns to normal operation. At that time the YELLOW LED will turn off and any external alarms connected to the monitor's alarm relays will also turn off. The HGM-RD will return to normal operation the next time it polls the affected monitor.

### Viewing Fault Log

A data log of the last 20 fault conditions is retained in memory. From the **Fault Screen** press ENTER to display the fault log.

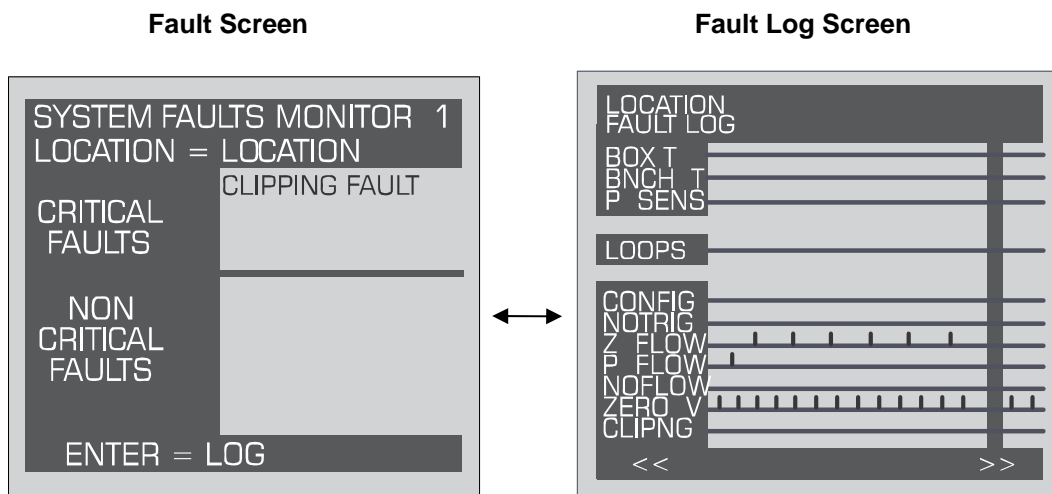

The Fault Log screen lists potential fault conditions in the left column. It also displays a check mark (?) indicating which problems were associated with each fault condition, as represented by the vertical cursor bar. As you move the bar horizontally using the LEFT/RIGHT cursor keys, the date and time the fault condition was detected is displayed in the upper right hand corner of the display window.

Anytime the fault status changes, there is an entry in the fault log, both when the fault occurs and when it is cleared.

# The Calibration Screen

## Overview

The **Calibration Screen** is used to adjust the calibration factor for each refrigerant gas. It is also used to program the instrument for new gasses.

**IMPORTANT:** Changing information on CAL FACTORS will VOID the factory calibration. Typically, the unit will remain within the factory-calibrated accuracy indefinitely and no calibration is required. Complex software algorithms adjust for temperature drift, IR source aging, and pressure changes in order to keep the unit within factory accuracy specifications.

## Navigating to the Calibration Screen

On the **System Screen**, select the target HGM-MZ unit and access that monitor's **Setup Screen #1**. Then select the CAL option to go to the selected monitor's **Calibration Screen**.

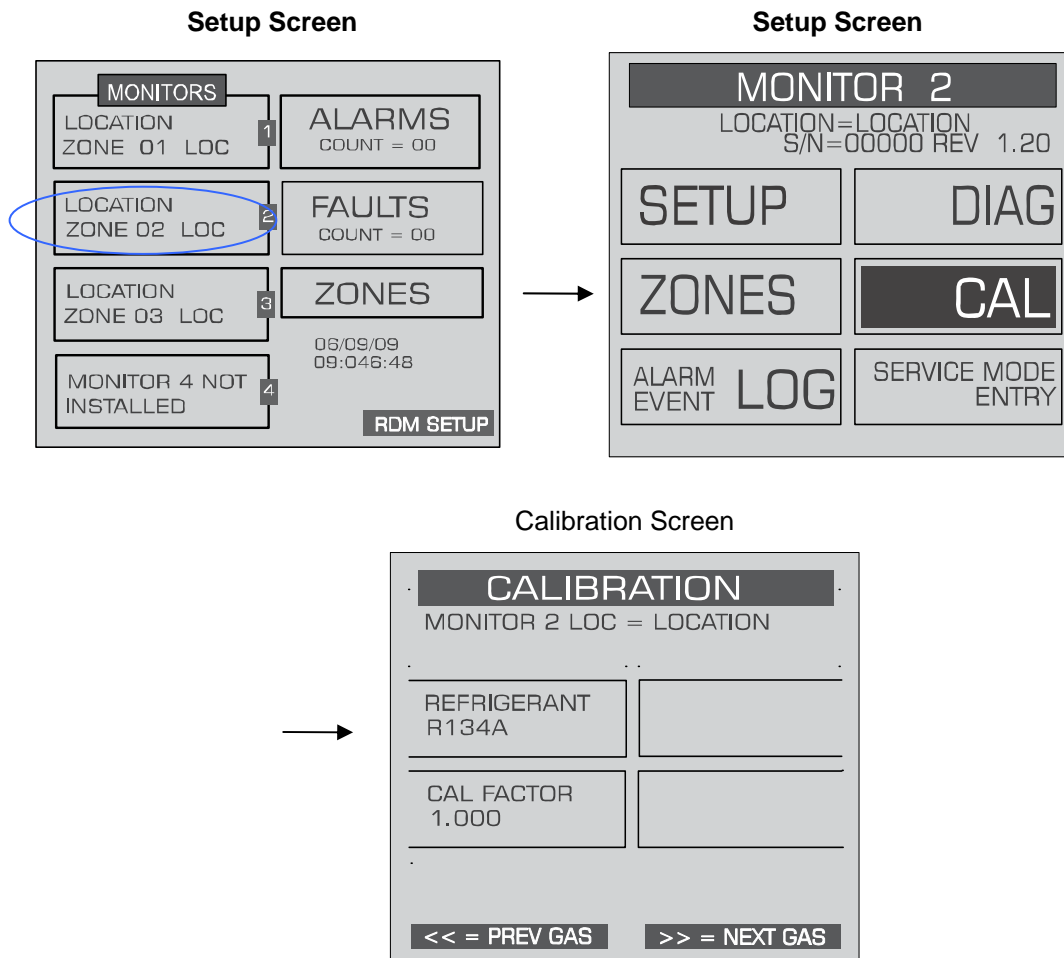

## Adjusting Calibration Factor

The factory default cal factor for standard units is 1.000. This value may be different if the high accuracy option is ordered.

Modifications to calibration must be done on each monitor. If calibration is attempted from the RD unit, the "Use monitor front panel interface to adjust calibration" message is displayed.

## Calibration Procedure on Main Monitor

The CAL FACTOR is determined by sampling a known dilution of the type of refrigerant gas to be sampled. The sample must be prepared to less than half the desired accuracy and the concentration must be corrected for ambient temperature and pressure at the time of measurement.

Calibration is best performed at or near full scale (1,000 PPM). It can, however, be done at any concentration, and ideally in the range where maximum accuracy is desired down to, but not below, 100 PPM.

A cylinder of refrigerant gas at a certified PPM level must be used to assure sampling occurs at ambient conditions. A minimum sample size of 5 liters is required.

The HGM should be operating for at least one hour prior to performing a calibration.

Prepare the HGM-MZ for sampling by initially setting its CAL FACTOR to 1.000 (Page 42). Next, set up the HGM-MZ for a logging interval of zero minutes (Page 26), and place the HGM-MZ in its zone hold mode for the zone you wish to use for calibration purposes (Page \_\_\_\_).

Connect the sample bag directly to the intake port for the zone you have set up and allow the HGM-MZ to sample the entire bag. When sampling is complete, view the trend data for the zone used to sample (Page 38). Read the measured PPM by placing the cursor on the spikes caused by the sample. If the bag was large enough for multiple samples, average the most stable ones.

The new CAL factor is computed by dividing the known gas value by the measured value. Typically this value will be between 0.95 and 1.05. Enter the computed CAL factor into the monitor using the HGM-RD (Page 42) or PC software. This value is stored in non-volatile memory.

## Programming New Gasses (*I didn't see any option on the unit to perform this. Did I miss something?*)

As new refrigerants come into use the HGM-MZ allows the addition of these new gases to its on-board refrigerant gas library. At the end of the gas library list is an option labeled CUSTOM for adding new gases. From the **Calibration Screen** use the LEFT/RIGHT arrows to select CUSTOM from the list of refrigerants. Next, press ENTER, and use the UP/DOWN arrow keys to enter the calibration factor. The selection of the matching gas and CAL factor is performed by Bacharach by analyzing the new refrigerant. When the matching gas is determined, field calibration is possible by using the same procedure as for other refrigerants. When the new gas entry is complete, setup the appropriate zone for CUSTOM.

Program the instrument for a new gas as follows:

From the **Calibration Screen**, use the PREV GAS or NEXT GAS options to scroll through the list of available choices until the CUSTOM option is displayed.

### Custom Gas Screen?

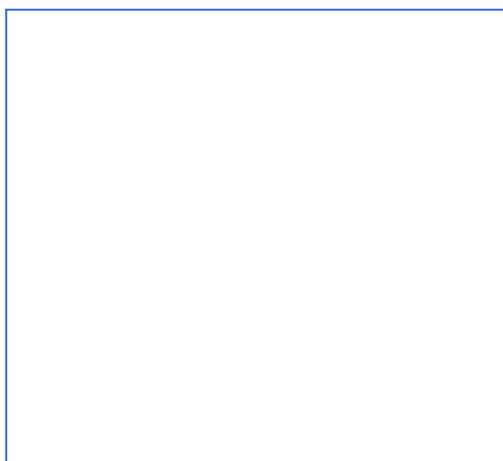

1. Select the CUSTOM option to assign a name to the refrigerant.
  - a. Use the LEFT/RIGHT cursor keys to move across the entry field and the UP/DOWN cursor keys to modify the individual characters.
  - b. Press ENTER to accept the new entry or ESC to revert to the previous setting.
2. Enter the new CAL Factor as received from Bacharach.

## The Diagnostic Screen

### Overview

The **Diagnostic Screen** displays reference values for use by repair technicians for troubleshooting purposes.

### Navigating to the Diagnostic Screen

On the **System Screen**, select the HGM-MZ unit you wish to view and press ENTER. That monitor's **Setup Screen** will appear. Press the DIAG key to go to the selected monitor's **Diagnostic Screen**.

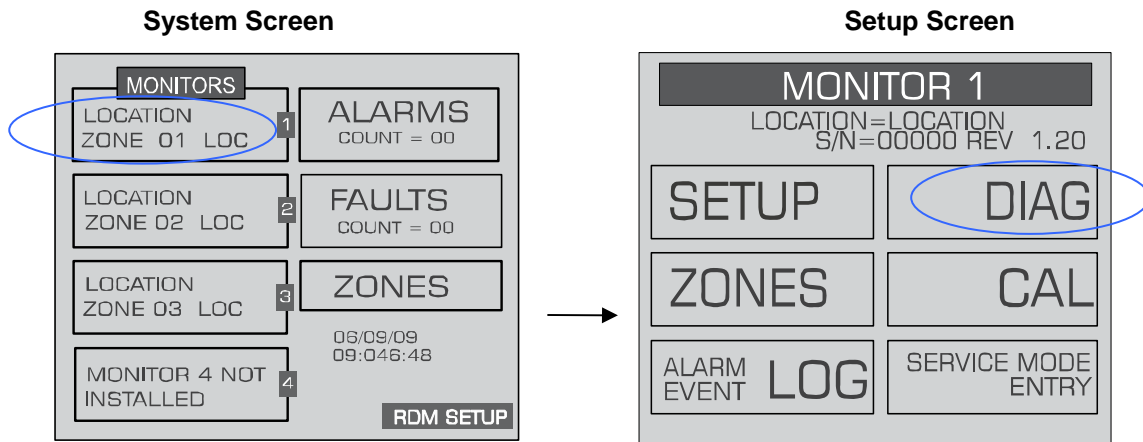

### Diagnostic Screen

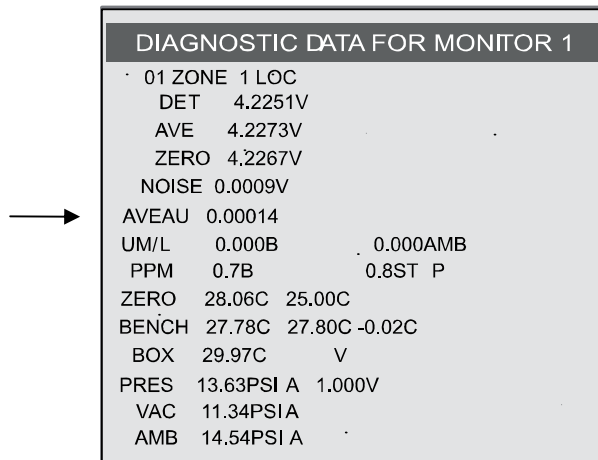

## Diagnostic Screen Overview

The **Diagnostic Screen** contains sensor data and status information useful for trouble shooting various fault conditions. An explanation of each line is given below along with normal operating ranges.

**LINE 1: Detector Voltage** – This is the peak-to-peak output of the IR sensor, in the absence of refrigerant this value can range from 3.900V to 4.500V.

**LINE 2: Average Detector Voltage** – This is simply a running average of the values displayed in line 1.

**LINE 3: Zero Voltage** – This is the IR sensor output that was stored during the last purge cycle and has the same range as line 1.

**LINE 4: Noise** – This is a 16 point running average of the noise portion of IR bench output. This reading is valuable mainly when refrigerant is NOT present.

**LINE 5: Average Absorbency** – This is the optical absorbency computed from the values in lines 2 and 3. In the absence of refrigerant the absorbency is 0.000AU. When sampling refrigerants, its value varies proportionally with the refrigerant concentration.

**LINE 6: uMoles/L** – This is the absolute concentration in micro-moles per liter of refrigerant based on line 4 and the internal calibration. There are two figures given. The first (which is annotated by a B) is the actual measurement at the IR bench. The second is the calculated value corrected to ambient conditions (temperature + pressure).

**LINE 7: PPM** – Parts Per Million is the volume concentration referenced to standard temperature and pressure and is computed from lines 5, 8 and 13. There are two figures given. The first (annotated by a B) is the actual PPM at the IR bench. The second is a PPM reading normalized to standard temperature and pressure.

**LINE 8: Zero Temperature** – This line contains the sensor and enclosure temperature measured and stored during the last purge cycle in degrees C.

**LINE 9: Bench Temperature** – This is the current IR sensor temperature in degrees C as well as the raw voltage coming from the temperature sensor itself. This value can range from ambient to ambient +15 degrees C.

**LINE 10: Box Temperature** – This is the current internal enclosure temperature along with the raw voltage from the temperature sensor, and has the same range as line 9.

**LINE 11: Pressure** – This is the current absolute manifold pressure in PSIA along with the output voltage of the pressure sensor. This value should always be 0.2 to 1.0 PSIA below ambient (line 13).

**LINE 12: Vacuum** – The vacuum pressure is measured every purge cycle by closing all sample valves. Its value is typically 2.5 to 4.0 PSIA below ambient (line 13).

**LINE 13: Ambient** – Ambient pressure is measured every purge cycle with the sample pump off and the manifold open. Its value is weather and altitude dependent and can range from 10.0 to 15.5 PSIA.

## Service Mode

When activated, the Service Mode will disable a specific HGM-MZ unit for a specified length of time. The default is 60 minutes. This time interval can be changed as described in the *Service Timeout* section on Page 26.

**IMPORTANT:** Note that while in the Service Mode, no measurements are made, nor are alarms activated.

*(I couldn't get this to work, so I need definition on this section.)*

From the **System Screen**, select the HGM unit you wish to place into Service Mode. On **HGM Setup Screen #1**, select SERVICE MODE ENTRY. An option will appear to continue to "IN SERVICE" or to "QUIT". To continue to IN SERVICE, select that option and press the ENTER key **twice within 3 seconds**.

Note that the **System Screen** will display which monitors are in the Service Mode.

To exit the Service Mode, select QUIT.

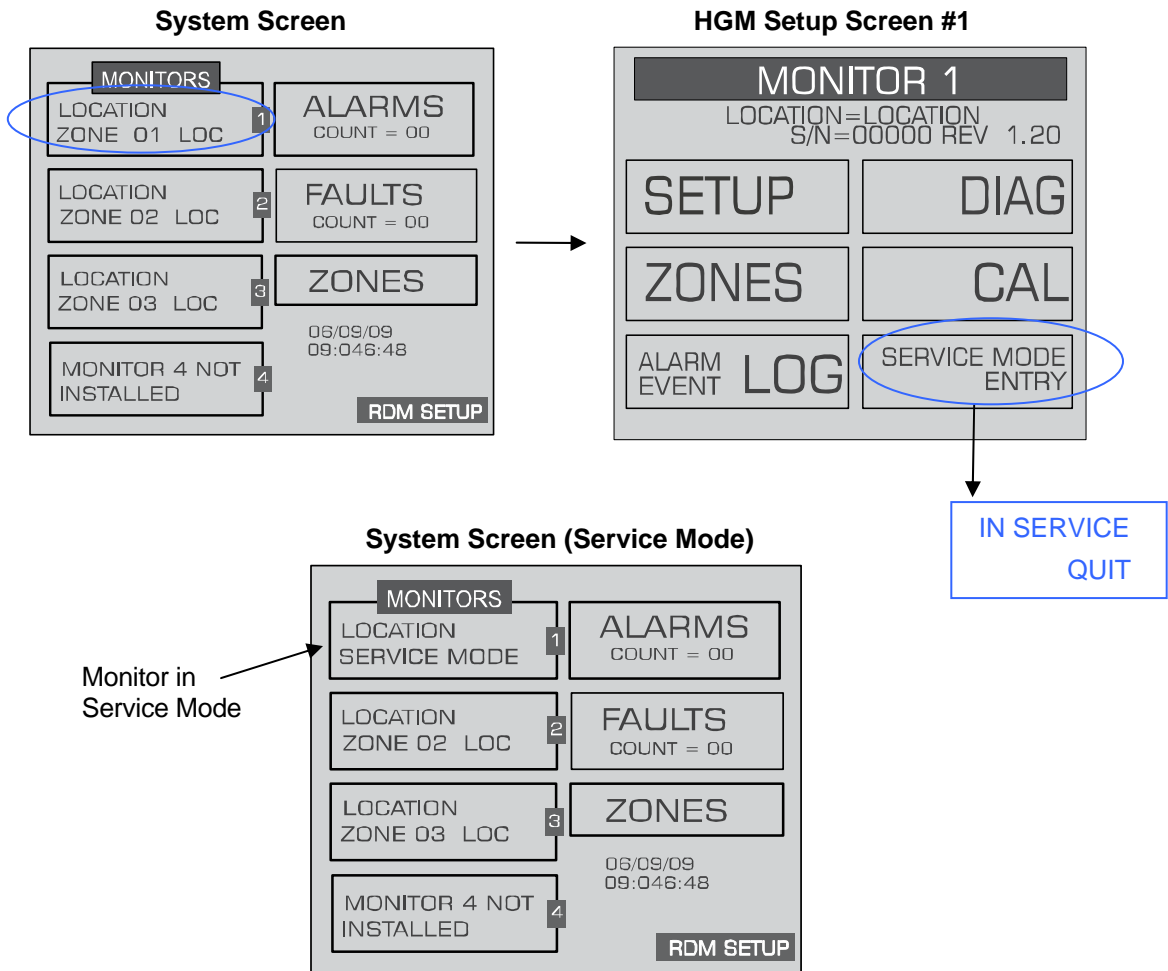

# 5 Maintenance

## Warnings and Cautions



**WARNING:** *Shock hazard! Always disconnect AC power before working inside the monitor.*

**CAUTION:** *The HGM-RD contains sensitive electronic components that can be easily damaged. Be careful not to touch or disturb any of these components.*

## ***Servicing Air Lines & Termination Filters***

System air lines (P/N 3015-3235) should be checked periodically for obvious signs of kinks, damage, and contamination. Replace the tubing as required.

The end-line filters (P/N 3015-3420) should be checked periodically and replaced when there are obvious signs of contamination. To service the filter simply remove it from the air line and replace it with a new filter.

# Appendix

## Logic Diagram

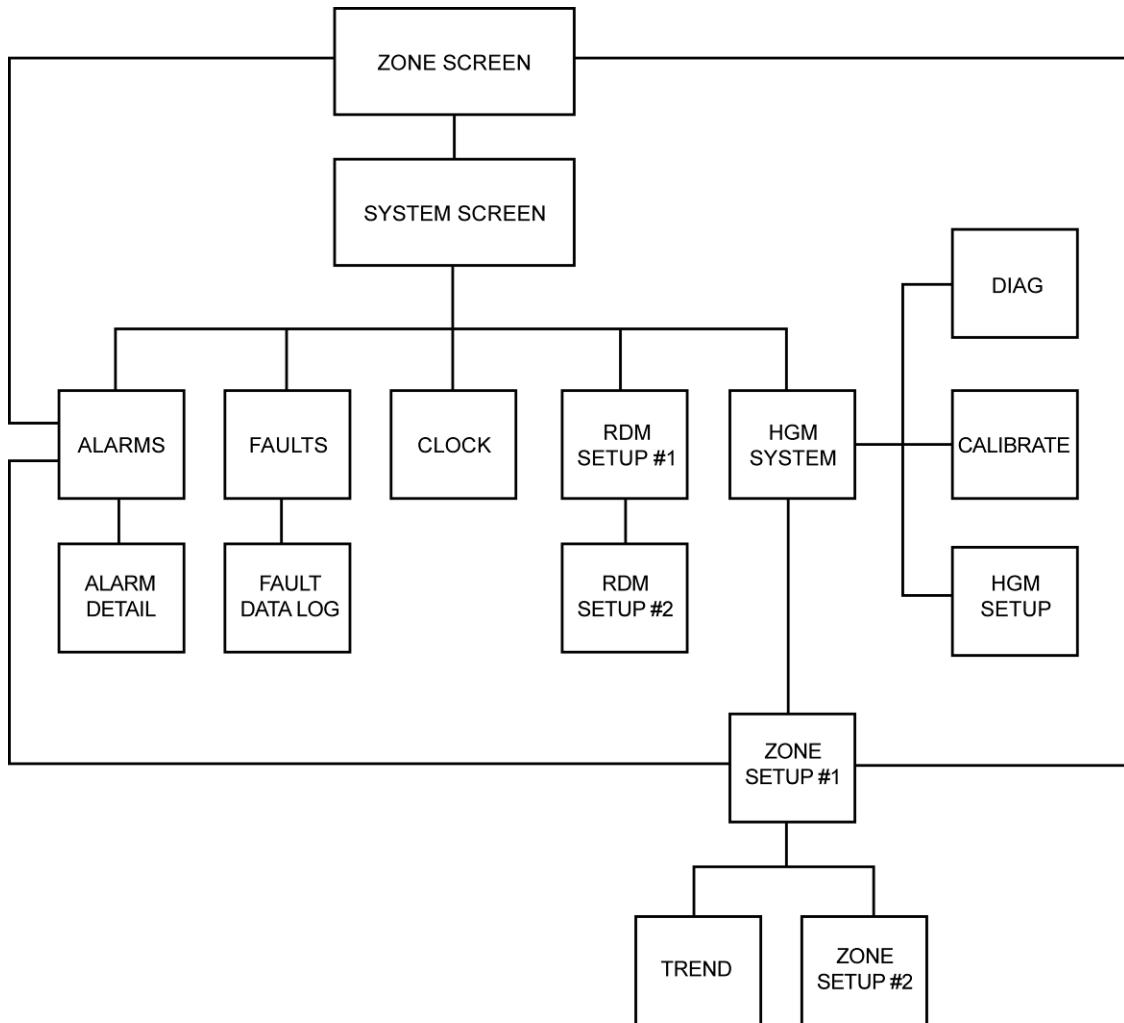

## Recommended Alarm Settings

Refrigerant	Leak PPM	Spill PPM	Evacuate PPM	Decimal	Hex
R11	100	300	500	0	00
R12	100	300	500	1	01
R22	100	300	500	2	02
R23	100	300	500	3	03
R113	100	300	500	4	04
R114	100	300	500	5	05
R123	25	35	35	6	06
R124	100	300	500	7	07
R134A	100	300	500	8	08
R401A	100	300	500	9	09
R402A	100	300	500	10	0A
R402B	100	300	500	11	0B
R404A	100	300	500	12	0C
R407A	100	300	500	13	0D
R407C	100	300	500	14	0E
R409A	100	300	500	15	0F
R410A	100	300	500	16	10
R500	100	300	500	17	11
R502	100	300	500	18	12
R503	100	300	500	19	13
R507	100	300	500	20	14
R508B	100	300	500	21	15
H1301	100	300	500	22	16
R408A	100	300	500	23	17
FA188	100	300	500	24	18
R236FA	100	300	500	25	19
N1230	100	300	500	26	1A
R227	100	300	500	27	1B
HFP	100	300	500	28	1C
FC72	100	300	500	29	1D
R21	100	300	500	30	1E
R125	100	300	500	31	1F
H1211	100	300	500	32	20
H2402	100	300	500	33	21
Custom	100	300	500	34	22

Allowable Exposure Level (AEL) ASHRAE 34-1992.

## ***RS-485 Communication Protocol***

### **Overview**

The following instructions are intended as a guide for integrating the HGM-MZ network into a Building Management System. If you are unfamiliar with complex systems of this type, it is recommended that you contact Bacharach for technical assistance.

### **MODBUS RTU Protocol**

The HGM-MZ monitor communicates with master devices (such as the HGM-RD or a Building Management System) over the RS-485 serial interface. The monitor is configured with a two wire RS-485 serial bus, and therefore, data transmission occurs in ‘half-duplex’ mode. Consequently, only one device may be in transmit mode at any given time.

Programmers should refer to the ‘‘MODBUS Protocol Reference Guide’’ for details and more comprehensive instructions. The guide is available on the Modicon web site at:

[http://www.modicon.com/techpubs/TechPubNew/PI\\_MBUS\\_300.pdf](http://www.modicon.com/techpubs/TechPubNew/PI_MBUS_300.pdf)

Specific communication software is available at: <http://www.bacharach-inc.com/downloads.htm>

# HGM-MZ MODBUS RTU Operation

## Overview

The HGM-400 and HGM-RD are equipped to communicate with other equipment using the MODBUS RTU protocol. Using this communication channel a MODBUS master device may communicate with up to 15 HGM-MZ's on a communications network, exchanging measurement information, alarm data, fault data, history (logs and trends) and setup information. Additionally, the MODBUS master can control the operating state of an HGM-MZ, placing the HGM-MZ in any of its different operating modes. The network may be configured such that the HGM-MZ's are connected directly to the MODBUS master device, or the MODBUS master device may communicate with the HGM-MZ's through the HGM-RD.

**NOTE:** This document will assume that the reader is familiar with the various parameters used to setup the HGM-MZ, as well as the different operational modes that the HGM-MZ may be placed in. If you are unfamiliar with this information, please reference the HGM-MZ operations manual.

## Protocol Details

A two-wire RS-485 bus is used for transmission, therefore communication occurs in a Half-Duplex mode. The HGM-MZ is a slave device and will respond to queries in the MODBUS RTU format from a master device.

Two MODBUS functions are supported. They are function 03 (read holding register) and function 16 (Preset Multiple registers). Please refer to the MODBUS Protocol Reference Guide (available at [www.modicon.com/techpubs/techPubNew/PI\\_MBUS\\_300.pdf](http://www.modicon.com/techpubs/techPubNew/PI_MBUS_300.pdf)) for protocol detail and use instructions.

Using the two MODBUS functions, a master device may read, modify and write data and status information to any HGM on the network. HGM data is organized into structures (internal to the HGM-MZ) which can be accessed by the MODBUS registers defined in this document. A corresponding set of data structures should be maintained by the master device. These master device data structures become the destination for responses to read queries and sources for preset register commands. When a read holding register query is made by the master device the HGM-MZ responds by sending the contents of the structure referenced by the specified register. After the master validates the HGM-MZ response using the CRC bytes, it must then move the data into its matching data structure before individual items may be accessed or modified. Therefore, the master data structure should correspond to the HGM-MZ data structure byte for byte. Note that some data structures have been divided into multiple registers due to MODBUS RTU message length constrains. To change a setting in the HGM-MZ, the master device first reads the register structure that contains the data item to be modified, makes the desired change, then sends the structure back using the preset multiple register function. If the transaction is successful, the HGM-MZ sends the appropriate MODBUS response. It is the responsibility of the master device when making modifications to insure that all parameters transferred fall inside the working limits of the HGM-MZ.

## Notes on HGM-MZ Polling

After the HGM-MZ's are setup and operating, the master device need only poll each HGM for its status register which contains summary data of the HGM's alarms, faults, and operating state. If exceptions are detected through the status register and more details are required, additional registers can be examined. Also if current PPM values are required, the PPM register provides access to current PPM values for all zones. The HGM-MZ requires a minimum of 20 seconds to complete a gas concentration measurement for a single zone. Therefore, it is not necessary to poll the HGM-MZ more frequently than once every 15-20 seconds, as there will not be any new data available/obtained by more frequent polling. In fact, excessive polling will slow the operation of the HGM-MZ. Under no circumstances should the HGM-MZ be continuously polled at rate faster than 500mS, as this could result in erroneous readings by the HGM-MZ.

## Notes on Network Topologies

HGM-MZ's may be connected directly to the MODBUS network or they may be connected to the network through an HGM-RD. In either case, each HGM-MZ must have a unique node ID. Up to 15 HGM-MZ's can be connected directly to the MODBUS network.

If HGM-MZ's are accessed via an HGM-RD connected to a MODBUS network, the HGM-RD "BMS enabled" parameter must be set equal to "1" via the "RDM SETUP" screen on the HGM-RD. The same commands

and registers are used to communicate with the HGM-MZ directly or through the HGM-RD. If the communications is through the HGM-RD, it monitors each MODBUS message to determine if the message is intended for one of the HGM-MZ's it is connected to. If it is, the HGM-RD passes the message through to the HGM-MZ's. If it is not, the message is not passed through. The HGM-RD does not make any modifications to MODBUS messages. It simply passes the query through to the HGM-MZ, and passes the response back to the MODBUS master. In other words, it allows the HGM-MZ's to be logically connected to the MODBUS network, when physically they are connected to the local HGM-RD network. It is very important to understand that the HGM-RD will only pass messages through to the HGM-MZ when the HGM-RD is either in the "SYSTEM" screen or the "ZONE VIEW" screen. If the HGM-RD is in any other screen, it will return a MODBUS "busy" exception response (exception code 06).

All HGM-RD screens, except the SYSTEM and ZONE VIEW screens, have a 10 minute timeout interval, after which the screen will return to either the SYSTEM or ZONE VIEW screen, depending on which one it was last in. Also, the HGM-RD can be password protected such that a password entry is required in order to view screens other than the SYSTEM or ZONE VIEW screen.

## Key Comm Protocol Parameters

MODBUS Mode: RTU only

**HGM-MZ Baud Rate:** Default is 19,200. Programmable as defined in System data register

**Parity:** No Parity

**Stop Bits:** Default is 1. Can be set for 2 via System data register

**Maximum Response Time:** 4000mS when directly accessing the HGM-MZ. 8,000mS when accessing the HGM-MZ through the HGM-RD.

**Error Checking:** CRC per MODBUS specifications

Also of note is the fact that all data sent out from the HGM-400 is in "little endian" byte order (Least significant byte followed by most significant byte). This should be taken into account if the master that process the data is a "big endian" type. Non-data information (starting address, number of points, etc.) follows normal MODBUS protocol, which is Big Endian.

## Summary of Registers

Register Name Number	HEX	Decimal	Description
System Data	0x0010	16	R/W HGM System Setup Data
Status	0x0011	17	R/W Operating summary of faults, alarms and status
Zone Data	0x12xx	4609 - 4630	R/W Setup data for up to 16 zones (xx defines zone number)
CAL Data	0x0014	20	R/W Cal Factors for all gases
Date/Time	0x0015	21	R/W Set HGM-MZ date & time
Sensor Data	0x0016	22	R Raw measurement of sensors
Rel. Hold	0x0017	23	W Release HGM-MZ out of hold mode
Hold Zone	0x0018	24	W Put HGM-MZ into hold mode
Fault Log	0x19xx	6400 6401	R 20 most recent fault events (xx = 00 or 01)
Flow Log	0x001F	31	R 20 most recent flow fault events
Alarm Log	0x1Axx	6656 6657 6658	R 20 most recent alarm events (xx = 00, 01, or 02)
Serv. Mode	0x001B	27	W Puts HGM-MZ into service mode
Rel Serv.	0x001C	28	W Release HGM-MZ from service mode
PPM	0x001E	30	R PPM values for all zones
Zone Log	0x3yxx	0-6	Trend data for each HGM-MZ zone [y = zone number (starting at 0), xx = 00 – 06] Data
Data Type Abbreviations			
C	Character		
Float	Floating Point		
I	Integer		
TIM	Time		
UI	Unsigned Integer		

**System Data Register      Register 0x0010h   R/W   54 bytes**

Variable	Type	Length	Description
Type	UI	2 bytes	Indicates EEPROM has been initialized if value = 300 <b>DO NOT MODIFY</b>
REV	Float	4 bytes	Firmware Rev Level <b>DO NOT MODIFY</b>
SN	UI	2 bytes	Firmware Serial Number <b>DO NOT MODIFY</b>
Node	UC	1 byte	Network Slave Node # (valid values are 1-15). The default is that indicated by the Node DIP Switch on main board.
Location	C	13 bytes	Array defining text name of unit
Stop_Bits	C	1 byte	Number of stop bits used in the HGM-MZ data stream. Default = 1. Other available value is 2
Aud_Alarm	UC	1 byte	Sounds internal board buzzer on condition; 0 = no buzzer; 1= Alarm; 2=Fault; 3=Leak; 4=Spill; 5=Evacuate; 6=Monitor Off line (DEFAULT = 0)
Alarm_Ack_Mode	UC	1 byte	Defines Alarm Operation. Manual Acknowledge = 0; Auto Acknowledge = 1 (DEFAULT = 0)
Num_Zones	UC	1 byte	Number of install zones (Value initialized during auto detect during Power On Self Test).
UNUSED	TIM	13 bytes	UNUSED
Rezero_Mode	UC	1 byte	Defines rezero mode. Auto Rezero = 0; Rezero every zone = 1 (DEFAULT = 0)
Hold_Time	UI	2 byte	Length of zone hold interval in minutes (DEFAULT = 15 minutes)
Det_Limit	UC	1 byte	Minimum detection limit (in PPM). Concentrations less than or equal this value will read as 0 PPM (DEFAULT = 0 PPM)
Avg_Size	UC	1 byte	Size of running average used in computing PPM value. <b>DO NOT MODIFY.</b>
Loop2_factor	Float	4 bytes	Defines PPM current loop output. (DEFAULT = 0.16mA/PPM)
Serv_Mode_TO	UI	2 bytes	Service Mode Timeout value (in minutes). (DEFAULT = 60 MINUTES)
RS485_BAUD	UI	2 bytes	BAUD RATE for RS-485 connection (between HGM-RD and HGM-MZ or MODBUS master and HGM-MZ depending on the Network topology). Default=9 (19.2K); other values are 8=9600, 7=4800
UNUSED	UI	2 bytes	UNUSED

**Status Register      Register 0x0011h R/W 10 bytes**

Variable	Type	Length	Description
Mode	UC	1 byte	Defines Operating Mode of HGM-400. 0 = normal Mode; 1 = Zone_Hold Mode; 2 = Diagnostic Mode; 3 = Service mode. <b>DO NOT MODIFY (use zone hold register or service mode register to change this parameter)</b>
State	UC	1 byte	Defines HGM-400 Current State. 0 = Idle; 1 = Sampling; 2 = Zeroing; 3 = Warm Up, 4 = Pressure Check <b>DO NOT MODIFY</b>
Measuring	UC	1 byte	Value = 1 if unit is acquiring detector signal for running avg. <b>DO NOT MODIFY</b>
Active_Zone	UC	1 byte	Current Zone being checked. 0=zone1, 1=zone2, etc.
Max_Alarm	UC	1 byte	Indicates highest non-acknowledged alarm level <b>DO NOT MODIFY</b>
Alarm_Count	UC	1 byte	Number of alarms that are currently active <b>DO NOT MODIFY</b>
UNUSED	UC	1 byte	UNUSED
Loop_Card	UC	1 byte	Value = 1 if 4-20mA card has been detected <b>DO NOT MODIFY</b>
Fault	UI	2 bytes	See Note Below

**Fault Flag Structure uses bitwise access to 16 bit word as defined below:**

BIT	Fault Type	Code	Description
15	CLIPPING FAULT	0x8000	0x8000 Sensor output voltage too high
14	ZERO RANGE FAULT	0x4000	Sensor output voltage outside limits during purge
13	OVER RANGE FAULT	0x2000	Gas concentration above measurable range
12	PURGE FLOW FAULT	0x1000	No flow detected during purge cycle
11	ZONE FLOW FAULT	0x0800	No flow detected during sample cycle
10	A2D FAULT	0x0400	Analog to digital converter not working
9	GAIN SET FAULT	0x0200	Digipot gain setting out of normal range
8	ZERO FILTER FAULT	0x0100	Charcoal filter (if used) needs replacement
7	CONFIG FAULT	0x0080	No zones are enabled
6	UNUSED FAULT 2	0x0040	
5	UNUSED FAULT1	0x0020	
4	LOOP FAULT	0x0010	Current loop is open
3	RS485 FAULT	0x0008	Communication error
2	MANIFOLD P FAULT	0x0004	Pressure sensor readings are out of range
1	BENCH T FAULT	0x0002	Sensor temperature is out of range
0	BOX T FAULT	0x0001	Chassis temperature is out of range

## Zone Data Register 0x12xxh R/W 78 bytes

Each zone for an HGM-MZ has a separate Zone data structure that is 78 bytes long. The zone number is the low order byte in the register address (i.e., Zone 1 data register = 0x1201h)

Variable	Type	Length	Description
Location	C	13 bytes	13 byte array, Alpha Numeric Description or Name of Zone
Flow OK	UC	1 byte	Status of Flow check. Value of 1 indicates flow check is good. <b>DO NOT MODIFY</b>
Refrig. Type	UC	1 byte	See note 1 Below (DEFAULT = R134a)
Distance	UI	2 bytes	Zone Tubing Length (in feet) (DEFAULT = 100 feet)
Zone Temp	I	2 bytes	Avg temp at zone (degrees C) (DEFAULT = 25°C)
Concentration	Float	4 bytes	Last Measured concentrations (uM/L) <b>DO NOT MODIFY</b>
Concentration2	Float	4 bytes	Last Measured concentration (PPM) <b>DO NOT MODIFY</b>
Alarm Ack	UC	1 bytes	Set value to 1 to acknowledge Alarm. <b>NOTE:</b> HGM-MZ will reset this byte to 0 when the Alarm byte (below) is = 0 and zone in alarm is sampled. If the alarm condition/byte increases (leak>>spill or spill>>evac) the HGM-MZ will also reset this byte to 0
Alarm	UC	1 bytes	Alarm Status; 0 = no alarm, 1 = leak; 2 = spill; 3 = evac.
Leak Level	UI	2 bytes	Level to trigger a leak alarm (in PPM) (DEFAULT = 100)
Spill Level	UI	2 bytes	Level to trigger a spill alarm (in PPM) (DEFAULT = 300)
Evac Level	UI	2 bytes	Level to trigger a evacuate alarm (in PPM) (DEFAULT = 500)
Peak PPM	UI	2 bytes	Highest Recorded PPM in zone
Peak Time	TIM	13 bytes	Date and time of highest peak (see note 2 for format)
Alarm Time	TIM	13 bytes	Date and time of last alarm (see note 2 for format)
Not Used		13 bytes	
Log Interval	UI	2 bytes	Number of minutes between Log entries (DEFAULT = 1440)

**NOTE 1:** Refer to the **Recommended Alarm Settings & Gas Enumeration** table on page 46.

**NOTE 2:** Time Structure Format consists of 13 unsigned character types. They are 1 second digit, 10 second digit, 1 minute digit, 10 minute digit, 1 hour digit, 10 hour digit, 1 day digit, 10 day digit, 1 month digit, 10 month digit, 1 year digit, 10 year digit, last byte is unused.

## Notes on Alarms and Alarm Acknowledge

The HGM-MZ can be operated in two different alarm acknowledge modes, Auto and Manual (set via the `alarm_ack_mode` variable in the system data register). For purposes of this discussion, the term “Alarm” refers to a HGM-MZ state where the alarm light is on and the appropriate alarm relay is activated. The term “Alarm condition” refers to the external condition (i.e., refrigerant leak) that initially causes the HGM-MZ to go into an alarm. If an alarm occurs it can be handled in one of 3 ways.

- 1. Non-Latching Mode.** This mode is enabled by setting the `AUTO_ACK_MODE` parameter in the system register to “1”. In this mode, if an alarm condition occurs an HGM-MZ alarm will be created. If the alarm condition is subsequently removed, the HGM-MZ alarm will automatically be cleared by the HGM-MZ when the zone in alarm is sampled “clear”. Note, in this mode of operation, it is possible for an alarm to occur and be cleared without user or MODBUS master intervention. If this is the case, the only evidence of the alarm would be contained in the HGM-MZ alarm log.
- 2. Latching Mode with Silence.** This mode is enabled by setting the `AUTO_ACK_MODE` in the system register to “0”. In this mode, if an alarm condition occurs, an HGM-MZ alarm will be created. In order for the alarm to be removed the MODBUS master will write a “0” to the `ALARM` parameter in the `ZONE` register. This will cause the alarm to be “silenced” in the HGM-MZ (i.e., the alarm relays will return to their normal state and the `ALARM` lamp will be extinguished). The next time the zone with the alarm condition is sampled, if the alarm condition still exists, the alarm will be reactivated and the alarm parameter will be reset to “1” in the HGM-MZ. Otherwise, if the alarm condition has cleared, no further action is required and normal operation will resume.
- 3. Latching Mode without Silence.** This mode is enabled by setting the `AUTO_ACK_MODE` in the system register to “0”. In this mode, if an alarm condition occurs, an HGM-MZ alarm will be created. The HGM-MZ MODBUS master will then write a “1” to the `ALARM ACK` parameter in the zone register. The alarm will continue to persist (i.e., Relays in alarm state and Alarm light on) until the offending zone is sampled and no alarm condition is detected. At that point, the `ALARM ACK` parameter is automatically cleared by the HGM-MZ, as is the `ALARM` parameter. **NOTE:** If the `ALARM ACK` parameter is set to “1” and the `ALARM CONDITION` is upgraded (from leak to spill, or spill to evacuate) the `ALARM ACK` parameter will automatically be cleared to “0” by the HGM-MZ.

### Cal Data Register

Register 0x0014h R/W 174 bytes

Variable	Type	Length	Description
Factor	Float	132 bytes	33 element array containing cal factors for each of the 33 gases. Order of Cal Factor is defined in Note 1 under Zone Data
Curve	UC	3 bytes	Existing Master Curve to use for user defined "NEW GAS"
New Gas Name	C	39 bytes	3 x 13 array that contains the names for each of 3 new gases

**NOTE:** "Future" Gases are gases that will be added to the library at a later date. They will require generation of new cal curves that will be added to the code. "New" Gases can be added in the field by selecting a similar existing cal curve and then defining a cal factor that will bring the accuracy within the desired range. It is strongly recommended that any New Gas curves that are added be done in conjunction with help from Bacharach, Inc.

### Date Time Register

Register 0x0015h R/W 14 bytes

Variable	Type	Length	Description
Date_Time	Time	14 bytes	Contains current time and date. Structure is defined as in note 2 of zone data

Time Structure Format consists of 14 unsigned character types. They are 1 second digit, 10 second digit, 1 minute digit, 10 minute digit, 1 hour digit, 10 hour digit, a day digit, 10 day digit, 1 month digit, 10 month digit, 1 year digit, 10 year digit, day of the week, last byte is unused.

**Sensor Data Register      Register 0x0016h R      82 bytes**

Variable	Type	Length	Description
Pressure	Float	4	Manifold Pressure is PSIA
P_Volts	Float	4	Pressure sensor output Voltage
Vacuum_P	Float	4	Pressure with all value closed and pump on in PSIA
Ambient_P	Float	4	Absolute Ambient Pressure in PSIA
Box_T	Float	4	Enclosure Temperature in Degrees C
Box_T_Volts	Float	4	Box temp sensor output voltage
Bench_T	Float	4	Optical bench temperature in Degrees C
Bench_T_Volts	Float	4	Bench temp sensor output voltage
Bench_Z_T	Float	4	Optical bench temp in degrees C at last zero interval
Box_Z_T	Float	4	Box temp in degrees C at last zeroing
PkPk_int	UI	2	Current peak to peak A/D counts from detector
PkPk	Float	4	Current peak to peak voltage from detector
Ave_PkPk	Float	4	Running average voltage from detector
Zero_PkPk	Float	4	Voltage measured at last zeroing
Noise	Float	4	Largest Change in running average
AU	Float	4	Current absorbance value
Ave_AU	Float	4	Running Average of absorbance level
Bench_PPM	Float	4	PPM in bench based on zone gas selection (uncorrected for pressure and temperature)
STP_PPM	Float	4	PPM corrected to STP (1 atm, 25 deg C)
Bench_UML	Float	4	Micromoles/liter in bench (uncorrected)
Ambient_UML	Float	4	Micromoles/liter corrected to ambient pressure

**Release Zone Hold Register****Register 0x0017h W 10 bytes**

Variable	Type	Length	Description
Rel_Hold	*	*	See description of STATUS REGISTER

**Hold Zone Register****Register 0x0018h W 10 bytes**

Variable	Type	Length	Description
Zone_Hold	*	*	See description of STATUS REGISTER

**HGM-300 Hold Mode**

The HGM-400 can be made to hold or “dwell” on a particular zone if necessary. The length of the hold time is defined by the HOLD TIME parameter in the System Data Register.

**Placing the HGM-MZ into hold mode:**

1. Read the HGM-MZ Status Register (0x0011h)
2. Modify the content of the status register structure to change the MODE parameter to zone hold mode and the active zone parameter to the zone which you wish to hold.
3. Send this updated status register structure back to the HGM-MZ using PRESET MULTIPLE REGISTER COMMAND to the HOLD ZONE REGISTER (0x0018h).

**Releasing the Zone Hold**

1. Read the HGM-MZ Status Register (0x0011h)
2. Modify the content of the status register to change the MODE parameter to normal mode and the active zone parameter to the zone which you would like to resume normal activity on
3. Send this updated status register structure back to the HGM-MZ using PRESET MULTIPLE REGISTER COMMAND to the RELEASE HOLD REGISTER (0x0017h).

## Fault Log Register

Register 0x1900, 0x1901h

R

302 bytes

These registers contain the 20 most recent fault events, the time they occurred, and a pointer to the most recent event. The data is split into 2 registers. The first register contains 200 bytes and the second register contains 102 bytes. The results of these two register reads should be recombined into the Fault Log Data Structure after both have been received

Variable	Type	Length	Description
Fault	UI	40 bytes	20 most recent fault events. Each event is decoded as indicated in Fault Flag Structure given after the Status Register Description
Time	TIM	260 bytes	Time of each fault occurrence. TIM value as defined in NOTE 2 of Zone Data
Ptr	UC	1 byte	Pointer to most recent event
Unused	UC	1 byte	

## Alarm Log Register

Register 0x1A00h, 0x1A01h, 0x1A02h

R 582 bytes

These registers contain the 20 most recent alarm events, the time they occurred, and a pointer to the most recent event. The data is split into 3 registers and should be recombined into an appropriate structure after all three registers have been received. Register 0x1A00h contain 200 bytes, Register 0x1A01h contains 200 bytes, and register 0x1A02h contains 181 bytes.

Variable	Type	Length	Description
Event	UC	320 bytes	20 most recent alarm events. Each event contains 1 byte for each zone. Each zone Byte is defined as 0=No Alarm, 1=Leak Alarm, 2=Spill Alarm, 3=Evac Alarm.
Time	TIM	260 bytes	Time of each alarm event. TIM value as defined in NOTE 2 of Zone Data
Ptr	UC	1 byte	Pointer to most recent event
Unused	UC	1 byte	

**Service Mode Register****Register 0x001Bh W 10 bytes**

Variable	Type	Length	Description
Rel_Svc_Mode	*	*	See description of STATUS REGISTER

**Release Service Mode Register****Register 0x001Ch W 10 bytes**

Variable	Type	Length	Description
Ent_Svc_Mode	*	*	See description of STATUS REGISTER

**HGM-300 Service Mode**

The HGM-400 can be placed into service mode if necessary. During service mode the unit will take no measurements, any and all alarms are silenced, and all relays are opened. The unit automatically comes out of service mode after a preset interval defined by the service\_mode\_TO parameter in the System Data Register.

**Placing the HGM-MZ into Service Mode:**

1. Read the HGM-MZ Status Register (0x0011h)
2. Modify the content of the status register structure to change the MODE parameter to service mode.
3. Send this updated status register structure back to the HGM-MZ using PRESET MULTIPLE REGISTER COMMAND to the SERVICE MODE REGISTER (0x001Bh).

**Releasing the unit from Service Mode:**

1. Read the HGM-MZ Status Register (0x0011h)
2. Modify the content of the status register to change the MODE parameter to normal mode.
3. Send this updated status register structure back to the HGM-MZ using PRESET MULTIPLE REGISTER COMMAND to the RELEASE SERVICE MODE REGISTER (0x001Ch).

**PPM Register                      Register 0x001Eh R            32 bytes**

Variable	Type	Length	Description
PPM	UI	32 bytes	16 Unsigned Integers that represent the PPM values for each HGM-MZ zone

**NOTE:** 16 values are returned independent of the number of actual zones installed in the unit. The master device is required to know how many zones are installed in the unit (available in the System Register) in order to properly interpret the data.

**Zone Log Registers                      Register 0x3xyyh R            1502 bytes**

These registers are used to transfer the zone log data. Each zone has a circular log of 100 past data points. The period between data points is defined by the Log Interval parameter in each corresponding Zone Data Register. The data for each zone is defined by the “x” place in the above register address. For zone 1 the Register address is 0x30yyh, for zone 2 the register address is 0x31yyh, etc. The data for each zone is sent in 8 consecutive registers due to MODBUS RTU message length constrains. The addresses are defined by the “yy” place in the above address. For zone 1, all log data can be obtained by reading 0x3000h, 0x3001h, 0x3002h, ..... , 0x3007h. The first seven registers contain 200 bytes each and the last register contains 102 bytes. After all registers have been received the data should be reassembled into the full data structure.

Variable	Type	Length	Description
Index	UI	2	Point to current reading
Time	TIM	1300	Time record for each of the 100 log points. The format for the TIM type is defined in note 2 of zone data
PPM	UI	200	Last 100 log points (2 bytes per point)

**MODBUS EXCEPTION RESPONSES**

The following MODBUS exception responses are supported by the HGM-MZ:

- Illegal Function
- Illegal Data Address
- Slave Device Busy (Occurs only when HGM-MZ is connected to the bus through an HGM-RD and the HGM-RD is not in the SYSTEM or ZONE VIEW screen)

# Specifications

<b>HGM-RD Specifications</b>	
<b>Product Description</b>	The HGM-RD Remote Display Module provides remote programming, interrogation and display functionality to support the HGM-MZ0 Refrigerant Gas Monitor. The system design supports compliance to the refrigerant monitoring requirements of ANS/BSR ASHRE 15-1994.
<b>Inputs</b>	The HGM-RD accepts inputs from up to four HGM-MZ monitors. It offers a wide variety of displays and can fully program any associated monitor
<b>Display</b>	Back lit LCD.
<b>Data Logging</b>	The user may view a graphical display of the PPM trend for each zone.
<b>Power Indication:</b>	Green LED glows when AC power is applied
<b>Alarm Indication:</b>	Red LED glows and alarm condition is displayed
<b>Fault Indication:</b>	Yellow LED glows and fault condition is displayed
<b>Password Protection</b>	The HGM-RD can be password protected to prevent the unauthorized editing of setup parameters without disturbing the ability to monitor system outputs.
<b>Power Safety Mode</b>	Fully automatic system reset; all parameters maintained
<b>Monitoring Distance</b>	Up to 1500 feet from furthest HGM-MZ
<b>Communications:</b>	Full two-way communication with HGM-MZ monitors via RS-485 interface. Second RS-485 interface provided for connection to a Building Management System
<b>Relays:</b>	Two SPDT programmable alarm contacts are provided (rated 5A 120VAC)
<b>Operating Temp</b>	32 to 113 °F (0 to 45 °C)
<b>Ambient Humidity</b>	5 to 90% (non-condensing)
<b>Size/Weight</b>	11"H x 10"W x 3"D - 5 lbs.
<b>AC Power</b>	120 or 230 VAC, 50/60 Hz, 21 W
<b>Mounting</b>	Wall mount
<b>Certification</b>	UL #61010-1 and CE Mark
<b>Warranty</b>	2 years from date of shipment
<b>Altitude Limit</b>	6,562 ft (2,000 m)
<i>Specifications subject to change without notice</i>	



Headquarters:  
621 Hunt Valley Circle, New Kensington, PA 15068  
Website: [www.bacharach-inc.com](http://www.bacharach-inc.com) • E-mail: [help@bacharach-inc.com](mailto:help@bacharach-inc.com)

Printed in U.S.A.

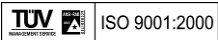

© Registered Trademark of Bacharach Inc.